

Canon

Digital Video Camcorder Instruction Manual

English

Camescope vidéo numérique Manuel d'instruction

Français

Videocámara digital Manual de Instrucciones

Español

optura Xi

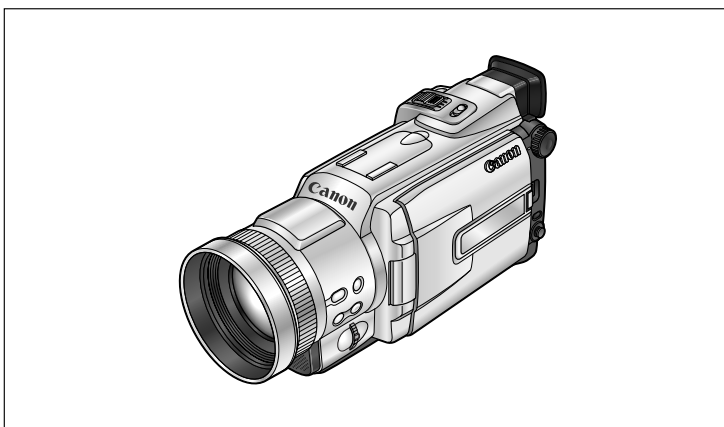

Mini DV Digital Video Cassette

BUBBLE JET DIRECT

DIRECT PRINT

PictBridge

NTSC

Important Usage Instructions

E

WARNING:



TO REDUCE THE RISK OF FIRE OR ELECTRIC SHOCK, DO NOT EXPOSE THIS PRODUCT TO RAIN OR MOISTURE.

WARNING:



TO REDUCE THE RISK OF ELECTRIC SHOCK AND TO REDUCE ANNOYING INTERFERENCE, USE THE RECOMMENDED ACCESSORIES ONLY.

COPYRIGHT WARNING:

Unauthorized recording of copyrighted materials may infringe on the rights of copyright owners and be contrary to copyright laws.

Introduction

Digital Video Camcorder, OPTURA Xi systems

This device complies with Part 15 of the FCC Rules. Operation is subject to the following two conditions: (1) This device may not cause harmful interference, and (2) this device must accept any interference received, including interference that may cause undesired operation.

Note: This equipment has been tested and found to comply with the limits for class B digital device, pursuant to Part 15 of the FCC Rules. These limits are designed to provide reasonable protection against harmful interference in a residential installation. This equipment generates, uses and can radiate radio frequency energy and, if not installed and use in accordance with the instructions, may cause harmful interference to radio communications. However, there is no guarantee that interference will not occur in a particular installation. If this equipment does cause harmful interference to radio or television reception, which can be determined by turning the equipment off and on, the user is encouraged to try to correct the interference by one or more of the following measures:

- Reorient or relocate the receiving antenna.
- Increase the separation between the equipment and receiver.
- Connect the equipment into an outlet on a circuit different from that to which the receiver is connected.
- Consult the dealer or an experienced radio/TV technician for help.

Use of shielded cable is required to comply with class B limits in Subpart B of Part 15 of FCC Rules.

Do not make any changes or modifications to the equipment unless otherwise specified in the manual.

If such changes or modifications should be made, you could be required to stop operation of the equipment.

Canon U.S.A. Inc.

One Canon Plaza, Lake Success, NY 11042, U.S.A.

Tel No. (516)328-5600

CAUTION:

TO PREVENT ELECTRIC SHOCK, MATCH WIDE BLADE OF PLUG TO WIDE SLOT, FULLY INSERT.

Important Warning



The lightning flash with arrowhead symbol, within an equilateral triangle, is intended to alert the user to the presence of uninsulated "dangerous voltage" within the product's enclosure, that may be of sufficient magnitude to constitute a risk of electric shock to persons.

CAUTION:

TO REDUCE THE RISK OF ELECTRIC SHOCK, DO NOT REMOVE COVER (OR BACK). NO USER-SERVICEABLE PARTS INSIDE. REFER SERVICING TO QUALIFIED SERVICE PERSONNEL.



The exclamation point, within an equilateral triangle, is intended to alert the user to the presence of important operating and maintenance (servicing) instructions in the literature accompanying the product.

IMPORTANT SAFETY INSTRUCTIONS

In these safety instructions the word “product” refers to the Canon Digital Video Camcorder OPTURA Xi A and all its accessories.

1. Read Instructions — All the safety and operating instructions should be read before the product is operated.
2. Retain Instructions — The safety and operating instructions should be retained for future reference.
3. Heed Warnings — All warnings on the product and in the operating instructions should be adhered to.
4. Follow Instructions — All operating and maintenance instructions should be followed.
5. Cleaning — Unplug this product from the wall outlet before cleaning. Do not use liquid or aerosol cleaners. The product should be cleaned only as recommended in this manual.
6. Accessories — Do not use accessories not recommended in this manual as they may be hazardous.
7. Avoid magnetic or electric fields — Do not use the camera close to TV transmitters, portable communication devices or other sources of electric or magnetic radiation. They may cause picture interference, or permanently damage the camera.
8. Water and Moisture — Hazard of electric shock — Do not use this product near water or in rainy/moist situations.
9. Placing or Moving — Do not place on an unstable cart, stand, tripod, bracket or table. The product may fall, causing serious injury to a child or adult, and serious damage to the product. A product and cart combination should be moved with care. Quick stops, excessive force, and uneven surfaces may cause the product and cart combination to overturn.



10. Power Sources — The CA-570 Compact Power Adapter should be operated only from the type of power source indicated on the marking label. If you are not sure of the type of power supply to your home, consult your product dealer or local power company. Regarding other power sources such as battery power, refer to instructions in this manual.
11. Polarization — The CA-570 Compact Power Adapter is equipped with a polarized 2-prong plug (a plug having one blade wider than the other). The 2-prong polarized plug will fit into the power outlet only one way. This is a safety feature. If you are unable to insert the plug fully into the outlet, try reversing the plug. If the plug still fails to fit, contact your electrician to replace your obsolete outlet. Do not defeat the safety purpose of the polarized plug.
12. Power Cord Protection — Power cords should be routed so that they are not likely to be walked on or pinched by items placed upon or against them. Pay particular attention to plugs and the point from which the cords exit the product.
13. Outdoor Antenna Grounding — If an outside antenna is connected to the product, be sure the antenna is grounded so as to provide some protection against voltage surges and built-up static charges. Section 810 of the National Electrical Code, ANSI / NFPA No. 70—1984, provides information with respect to proper grounding of the mast and supporting structure, grounding of the lead-in wire to an antenna discharge unit, size of grounding conductors, location of antenna discharge unit, connection to grounding electrodes, and requirements for the grounding electrode. See figure 1.

E

Introduction

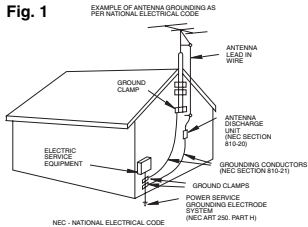

14. **Lightning** — For added protection of this product during a lightning storm, or when it is left unattended and unused for long periods of time, disconnect it from the wall outlet and disconnect the antenna. This will prevent damage to the product due to lightning and power-line surges.
15. **Overloading** — Do not overload wall outlets and extension cords as this can result in a risk of fire or electric shock.
16. **Objects and Liquid Entry** — Never push objects of any kind into this product through openings as they may touch dangerous voltage points or short out parts that could result in a fire or electric shock. Be careful not to spill liquid of any kind onto the product.
17. **Servicing** — Do not attempt to service this product yourself as opening or removing covers may expose you to dangerous voltage or other hazards. Refer all servicing to qualified service personnel.
18. **Damage Requiring Service** — Disconnect this product from the wall outlet and all power sources including battery, and refer servicing to qualified service personnel under the following conditions:
 - a. When the power-supply cord or plug is damaged.
 - b. If any liquid has been spilled onto, or objects have fallen into, the product.
 - c. If the product has been exposed to rain or water.
 - d. If the product does not operate normally even if you follow the operating instructions. Adjust only those controls that are covered by the operation instructions. Improper adjustment of other controls may result in damage and will often require extensive work by a qualified technician to restore the product to its normal operation.
 - e. If the product has been dropped or the cabinet has been damaged.
 - f. When the product exhibits a distinct change in performance. This indicates a need for service.
19. **Replacement Parts** — When replacement parts are required, be sure the service technician has used replacement parts that are specified by Canon or that have the same characteristics as the original part. Unauthorized substitutions may result in fire, electric shock or other hazards.
20. **Safety Check** — Upon completion of any service or repairs to this product, ask the service technician to perform safety checks to determine that the product is in safe operating order.

When replacement of power supply is required, please return it to the responsible nearest Canon Service Center and please replace it with the same type number CA-570.

The Adapter can be used with a power supply between 100 and 240 V AC. For areas where 120 V AC power is not used, you will need a special plug adapter. Contact your nearest Canon Service Center for further information.

Reference Guide

The following manuals are supplied with the camcorder:

E

○ **Digital Video Camcorder OPTURA Xi Instruction Manual**

This manual explains the camcorder operations from basic video recording to the use of the full range of features.

○ **Digital Video Software Instruction Manual**

This manual explains how to download images from the memory card to a computer using the supplied USB cable. You can add sample images for Card Mix and My Camera settings from the supplied DIGITAL VIDEO SOLUTION DISK.

○ **Windows XP Users Only**

DV Network Software Instruction Manual

This manual explains how to connect the camcorder to a computer and use the following software:

- DV Messenger Version 2 (USB or IEEE1394): This software operates with Windows Messenger and allows you to perform videoconference and file transfer over the Internet, or to remotely access the camcorder at home.
- AV/C Camera Storage Subunit-WIA Driver (IEEE1394): Allows you to download/upload images to/from the computer and use the camcorder as a card reader/writer.

Introduction

Trademark Acknowledgements

- Canon and Bubble Jet are registered trademarks of Canon Inc.
-  is a trademark.
-  logo is a trademark.
- Windows® is either a registered trademark or trademark of Microsoft Corporation in the United States and/or other countries.
- Mac OS is a trademark of Apple Computer, Inc., registered in the United States and other countries.
- Other names and products not mentioned above may be registered trademarks or trademarks of their respective companies.

MPEG-4 Visual Consumer Recorded Video Decoders and/or Encoders

USE OF THIS PRODUCT IN ANY MANNER THAT COMPLIES WITH THE MPEG-4 VISUAL STANDARD IS PROHIBITED, EXCEPT FOR USE BY A CONSUMER ENGAGING IN PERSONAL AND NON-COMMERCIAL ACTIVITIES.

Table of Contents

E

Introduction

Reference Guide	5
Thank You for Choosing a Canon	9
Introducing the OPTURA Xi	10
Components Guide	11

Mastering the Basics

Preparations

Using a Household Power Source	15
Attaching and Charging the Battery Pack	16
Installing the Backup Battery	19
Preparing the Camcorder	20
Loading a Cassette	22
Using the Wireless Controller	24
Setting the Time Zone, Date and Time	25

Basic Recording

Recording Movies on a Tape	28
Zooming	30
Using the LCD Screen.....	32
Searching and Reviewing when Recording	35
Tips for Making Better Videos	36

Basic Playback

Playing Back a Tape	37
Playing Back on a TV Screen.....	40

Using the Full Range of Features

General

Menus and Settings	43
Changing the Remote Sensor Mode	51
Customizing the Camcorder	52
Using the Custom Key	53
Other Camcorder Settings	54

Recording

Changing the Recording Mode (SP/LP)	56
Recording Still Images on the Tape	57
Using the Built-in Flash	59
Using the Recording Programs.....	62
Using Digital Effects.....	65
Using the Multi-Image Screen	71
Turning Off the Image Stabilizer	73
Recording With the Self-Timer.....	74
Audio Recording	75
Using the VL-3 Video Light (Optional)	78
Using the VFL-1 Video Flash Light (Optional)	79
Using the DM-50 Microphone (Optional).....	81

Manual Adjustments

Adjusting the Focus Manually	82
Adjusting Exposure Manually.....	84

- Using the Zebra Pattern85
- Backlight Compensation85
- Setting the Shutter Speed (**Tv** Mode).....86
- Setting the Aperture (**Av** Mode)88
- Setting the White Balance89

Playback

- Magnifying the Image.....91
- Displaying the Data Code92
- Photo Search/Date Search.....94
- Returning to a Pre-marked Position95

Editing

- Recording to a VCR or Digital Video Device96
- Recording from Analog Video Devices (VCR, TV or Camcorder)98
- Recording from Digital Video Devices (DV Dubbing).....99
- Converting Analog Signals into Digital Signals (Analog-Digital Converter)101
- Replacing Existing Scenes (AV Insert)103
- Audio Dubbing.....105
- Connecting to a Computer Using a DV (IEEE1394) Cable108

Using a Memory Card

- Inserting and Removing the Memory Card109
- Selecting the Image Quality/Size110
- Recording Still Images on a Memory Card.....113
- Selecting the Focusing Point117
- Selecting the Drive Mode119
- Recording Panoramic Images (Stitch Assist Mode)121
- Recording MPEG-4 Movies on a Memory Card123
- Playing Back a Memory Card125
- Protecting Images128
- Erasing Images129
- Selecting Still Images for Printing (Print Order)130
- Combining Images (Card Mix)132
- Copying Still Images.....136
- Formatting a Memory Card138
- Connecting to a Computer Using a USB Cable139
- Memory Card Information141

Direct Printing

- Printing Still Images (Direct Printing)144
- Selecting the Print Settings (Style/Paper Settings).....147
- Printing with Print Order Settings151





Additional Information

- About the NETWORK Mode152
- Screen Displays153
- List of Messages157
- Maintenance.....160
- Troubleshooting164
- System Diagram167
- Optional Accessories168
- Specifications171
- Index173

Conventions Used in This Manual

Operating Modes

E

Operating Mode	Position of the POWER Switch	Position of the TAPE/CARD Switch
CAMERA	CAMERA	 (TAPE)
PLAY (VCR)	PLAY (VCR)	 (TAPE)
CARD CAMERA	CAMERA	 (CARD)
CARD PLAY (VCR)	PLAY (VCR)	 (CARD)

Available functions depend upon the operating mode. It is indicated as follows:

Introduction





CAMERA

: Function can be used in this mode.

CAMERA

: Function cannot be used in this mode.

Other Symbols and References

-  : Reference page number.
-  : Functions to be operated on the body of the camcorder.
-  : Functions to be operated on the wireless controller.
-  : Additional topics that complement the basic operating procedures.
-  : Precautions related to the camcorder operation.
- Capital letters are used to refer to buttons on the camcorder or the wireless controller.
- [] are used to refer to menu items displayed on the screen.
- "Screen" refers to the LCD and the viewfinder screen.

The serial number of this product can be found at the battery attachment unit of the camcorder. Write down the number and other information here and retain this book as a permanent record of your purchase to aid identification in case of theft.

Date of Purchase:

Model Name: OPTURA Xi A

Purchased From:

Serial No.:

Dealer Address:

Dealer Phone No.:







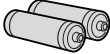

Thank You for Choosing a Canon

The Canon OPTURA Xi provides a full range of options and functions. We recommend reading this manual thoroughly before you use the camcorder. It will help you to become more familiar with your camcorder, and learn how to operate it properly. We suggest that you master the basic operations of the camcorder first, before moving on to its full range of features.

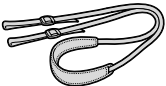
E

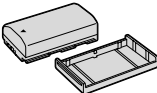
Checking Supplied Accessories

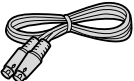
Introduction

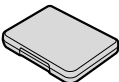
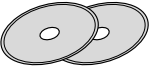
WL-D81 Wireless Controller 	Two AA Batteries 	Lens Hood 	Lens Cap and Lens Cap Cord 
SS-600 Shoulder Strap 	Lithium Button Battery CR2025 	BP-512 Battery Pack 	CA-570 Compact Power Adapter (incl. power cord) 
STV-250N Stereo Video Cable 	S-150 S-video Cable 	IFC-300PCU USB Cable 	SDC-8M SD Memory Card (containing sample images) 
Case for SD Memory Card 	DIGITAL VIDEO SOLUTION DISK For Windows For Macintosh 		

Introducing the **OPTURA Xi**

E

2 Megapixel CCD

The OPTURA Xi incorporates a 2 megapixel CCD, allowing recording of high-resolution still images on a memory card. (Tape: 1.23 megapixels)

11× Optical and 220× Digital Zoom (Card: 9× Optical and 36× Digital Zoom)

Optical Image Stabilizer

Canon's optical technology stabilizes your recording even in long telephoto shots.

Night and Super Night Mode

You can keep on shooting in dark places with the Night and Super Night mode. In the Super Night mode, the assist lamp (white LED) lights up to illuminate the subject.

Still Images

Just press the photo button to capture still images like photographs.

Built-in Flash

The OPTURA Xi has a built-in, pop-up flash for recording still images.

Custom Key

You can assign functions to the custom key.

Manual Audio Recording Level Adjustment

Analog Line-in Recording/ Audio Dubbing/AV Insert Editing

Advanced Accessory Shoe

Simply slide Canon's VFL-1 Video Flash Light, DM-50 Directional Stereo Microphone or VL-3 Video Light into the accessory shoe; the camcorder provides power and connections.

Digital Effects

Memory Card

You can record still images and MPEG-4 movies on a SD Memory Card or MultiMediaCard. Images recorded in Stitch Assist mode can be merged into one panoramic scene with the supplied software.

Direct Print

You can print still images by connecting to a Canon printer with Direct Print function or to a PictBridge-compliant printer.

USB Terminal

Allows transfer of memory card data to a computer with built-in USB port. You can organize and edit images on your computer using the supplied software.

IEEE1394 DV Terminal

The DV terminal allows high-quality transfer with virtually no deterioration in quality of images. You can edit images by connecting the camcorder to a PC with IEEE1394 terminal.

DV Messenger (Windows XP only)

Windows XP users can use the supplied software to perform videoconference and file transfer over the Internet by connecting the camcorder to a computer using a USB or DV (IEEE1394) cable.

* Windows Messenger 4.5, 4.6 or 4.7 required.

Components Guide

OPTURA Xi

E

Introduction

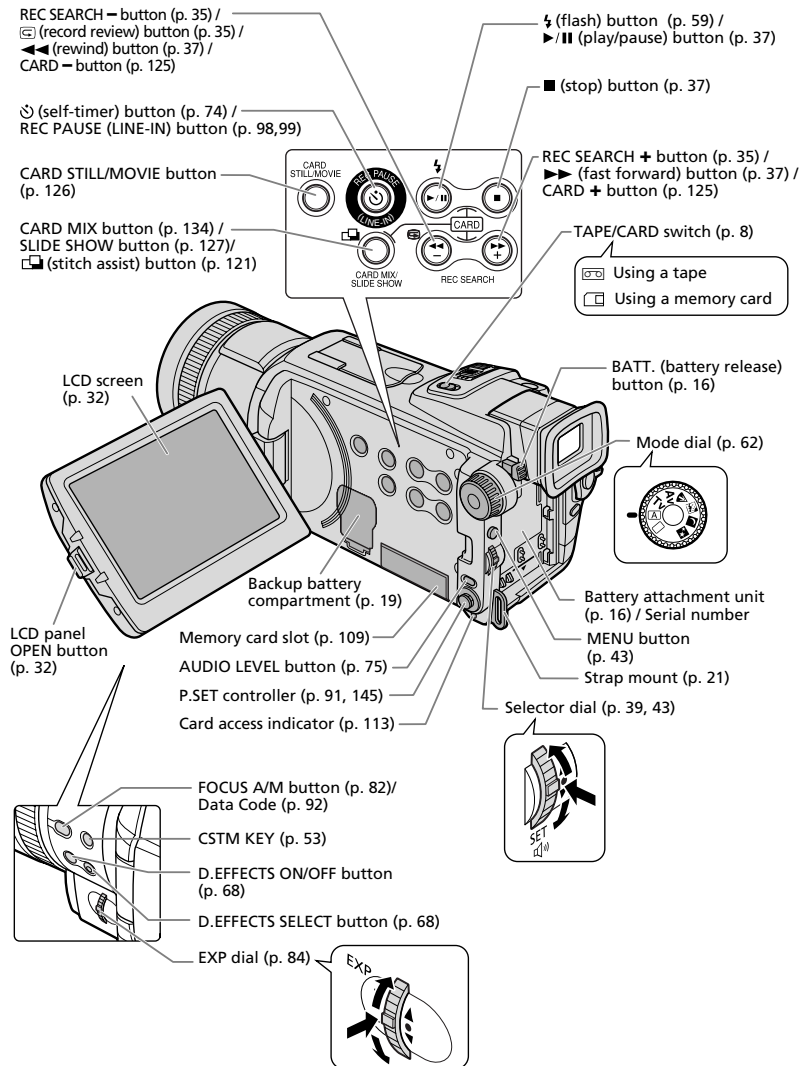

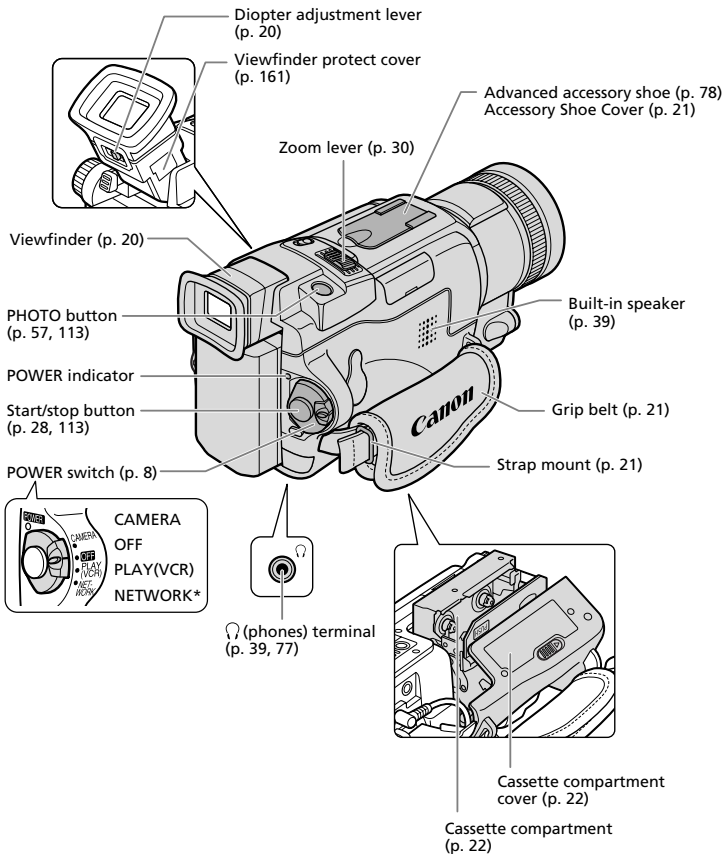

* The NETWORK mode is for use with DV Messenger (Windows XP users only). Press the small button below the POWER switch when switching to NETWORK (□ 152).

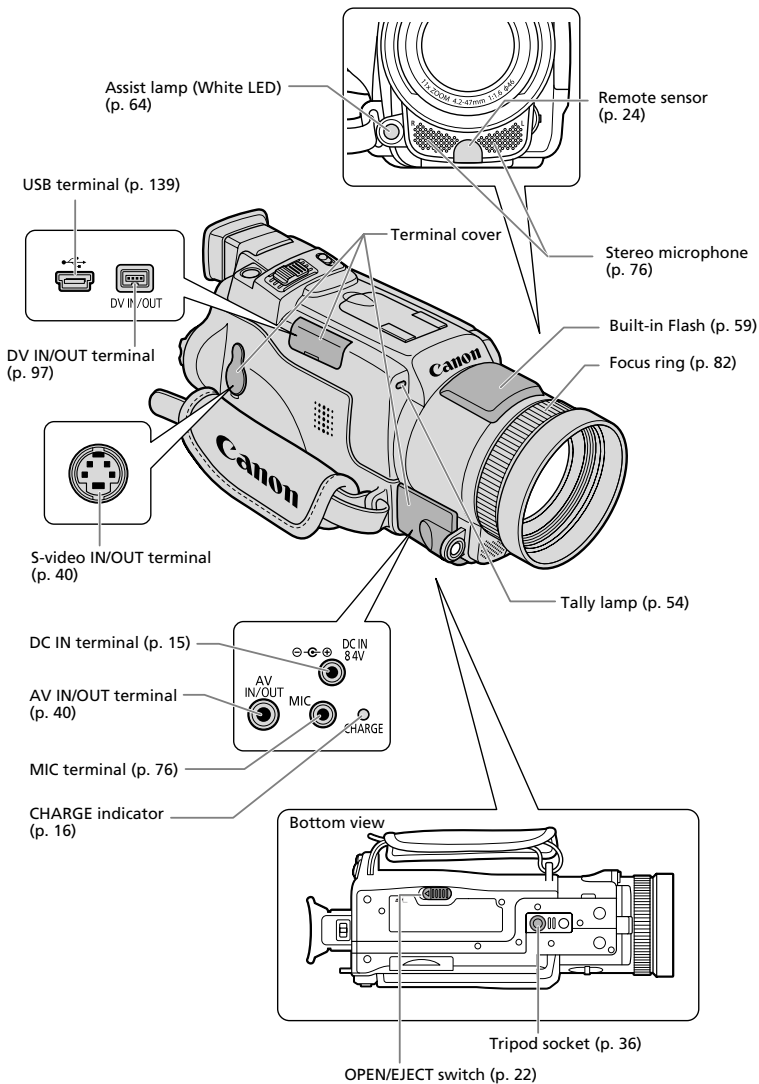

WL-D81 Wireless Controller

E

Introduction

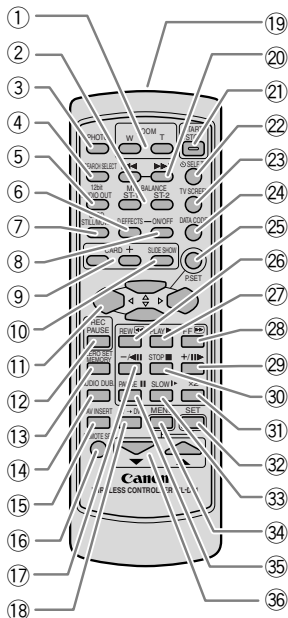

1 Zoom buttons (p. 30)	19 Transmitter
2 MIX BALANCE button (p. 107)	20 Search buttons (p. 94)
3 PHOTO button (p. 57, 113)	21 START/STOP button (p. 28, 123)
4 SEARCH SELECT button (p. 94)	22 ⏪ SELF T. button (p. 74)
5 12bit AUDIO OUT button (p. 107)	23 TV SCREEN button (p. 153)
6 D. EFFECTS (Digital effects) button (p. 68)	24 DATA CODE button (p. 92)
7 CARD STILL/MOVIE button (p. 126)	25 P.SET (Print set) button (p. 145)
8 Digital effects ON/OFF button (p. 68)	26 REW ◀◀ button (p. 37)
9 CARD -/+ buttons (p. 125)	27 PLAY ▶▶ button (p. 37)
10 SLIDE SHOW button (p. 127)	28 FF ▶▶▶ button (p. 37)
11 Direction buttons (p. 91, 145)	29 +/II▶▶ button (p. 38)
12 REC PAUSE button (p. 98, 99)	30 STOP ■ button (p. 37)
13 ZERO SET MEMORY button (p. 95)	31 x 2 button (p. 38)
14 AUDIO DUB. button (p. 106)	32 SET button (p. 43)
15 AV INSERT button (p. 104)	33 SLOW ▶▶▶ button (p. 38)
16 REMOTE SET button (p. 51)	34 MENU button (p. 43)
17 -/◀▶▶ button (p. 38)	35 PAUSE ■■ button (p. 38)
18 AV → DV button (p. 101)	36 Select buttons (p. 43)

Using a Household Power Source

You can operate the camcorder from a household power source using the supplied power adapter. The power adapter converts current from a power outlet (100-240 V AC, 50/60 Hz) to the DC current used by the camcorder.

E

1. Turn the **POWER** switch to **OFF**.
2. Connect the power cord to the power adapter.
3. Plug the power cord into a power outlet.
4. Connect the power adapter to the camcorder's DC IN terminal.

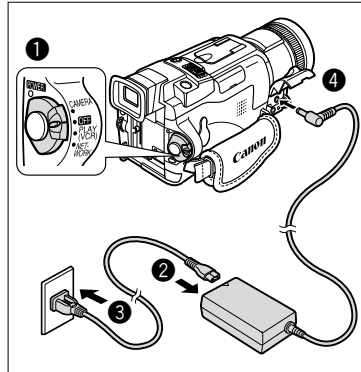

5. After use, turn off the camcorder and disconnect the power adapter from the camcorder. Unplug the power cord from the power outlet and disconnect it from the adapter.



- Turn off the camcorder before connecting or disconnecting the power adapter.
- If the adapter is used close to a TV, it may cause picture interference. Move the adapter away from the TV or the antenna cable.
- Do not connect any products that are not expressly recommended to the camcorder's DC IN terminal or to the power adapter.
- You may hear some noise from the power adapter during use. This is not a malfunction.

Attaching and Charging the Battery Pack

E

Charge the battery pack with the supplied power adapter before you use the camcorder for the first time and subsequently when the message "CHANGE THE BATTERY PACK" appears.

1. Turn the **POWER** switch to **OFF**.

2. Extend the viewfinder and move it upward.

3. Attach the battery pack to the camcorder.

- Remove the terminal cover of the battery pack.
- Align the end of the battery pack with the line on the camcorder, press lightly and slide it in the direction of the arrow until it clicks.

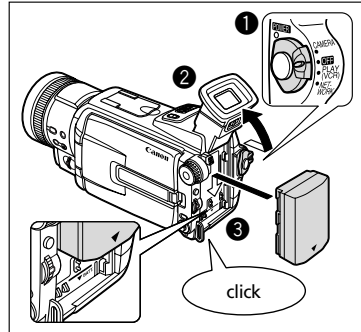

4. Connect the power cord to the adapter.

5. Plug the power cord into a power outlet.

6. Connect the power adapter to the camcorder's DC IN terminal.

7. When charging is complete, disconnect the power adapter from the camcorder. Unplug the power cord from the power outlet and disconnect it from the adapter.

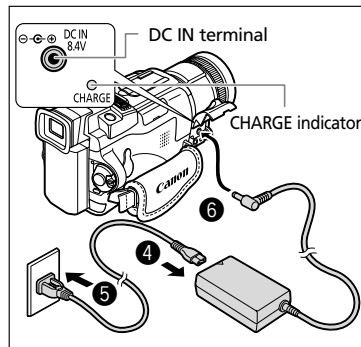

8. Remove the battery pack after use.

Press the BATT. button to remove the battery.



- The battery pack may be defective when the CHARGE indicator flashes rapidly.
- The CHARGE indicator informs you about the charge status.
 - 0-50%: Flashes once every second
 - More than 50%: Flashes twice every second
 - 100%: Glows steadily
- Do not disconnect and reconnect the power cord while charging a battery pack. The battery pack may not be charged correctly even if the CHARGE indicator glows steady. The battery pack may also not be charged correctly when a power outage occurs during charging. Remove the battery pack and attach it back to the camcorder.

Charging, Recording and Playback Time

Below times are approximate and vary according to the charging, recording or playback conditions.

Charging Time

Battery Pack	Charging Time
BP-512 (Supplied)	120 min.
BP-511 (Optional)	120 min.
BP-522 (Optional)	210 min.
BP-535 (Optional)	310 min.

- Charge the battery pack in temperatures between 41° F and 104° F (5° C and 40° C).
- A lithium ion battery pack can be charged at any charge state. Unlike conventional battery packs, you do not need to completely use or discharge it before charging.

Recording Time

Battery Pack	Maximum Recording Time		Typical Recording Time*	
	Using the viewfinder	Using the LCD	Using the viewfinder	Using the LCD
BP-512 (Supplied)	110 min.	90 min.	65 min.	50 min.
BP-511 (Optional)	110 min.	90 min.	65 min.	50 min.
BP-522 (Optional)	235 min.	185 min.	135 min.	105 min.
BP-535 (Optional)	375 min.	290 min.	215 min.	165 min.

* Approximate times for recording with repeated operations such as start/stop, zooming, power on/off. Actual time may be shorter.

- We recommend that you prepare battery packs 2 to 3 times longer than you think you might need.
- To conserve battery charge, turn off the camcorder instead of leaving it in record pause mode.

Playback Time

Battery Pack	Playback Time (Using the LCD)
BP-512 (Supplied)	115 min.
BP-511 (Optional)	115 min.
BP-522 (Optional)	250 min.
BP-535 (Optional)	400 min.

How much power is left?

The battery symbols indicate the charge status of the battery pack.

When the battery pack is empty, "CHANGE THE BATTERY PACK" appears for 4 seconds and  starts flashing.

The battery charge indicators are not constant – they vary according to the condition under which battery pack and camcorder are used.



E

Mastering
the Basics

Battery Pack Handling Precautions

DANGER!

Treat the battery pack with care.

- Keep it away from fire (or it might explode.)
 - Do not expose the battery pack to temperature higher than 140° F (60° C). Do not leave it near a heater or inside a car in hot weather.
 - Do not try to disassemble or modify it.
 - Do not drop or knock it.
 - Do not get it wet.
- Charged battery packs continue to discharge naturally. Therefore, charge them on the day of use, or the day before, to ensure a full charge.
 - Attach the terminal cover whenever a battery pack is not in use. Contact to metallic objects may cause a short circuit and damage the battery pack.
 - Dirty terminals may cause a poor contact between the battery pack and the camcorder. Wipe the terminals with a soft cloth.
 - Since storing a charged battery pack for a long time (about 1 year) can shorten its lifecycle or affect performance, we recommend to discharge the battery pack fully and to store it in a dry place at temperatures no higher than 86° F (30° C). If you do not use the battery pack for long periods, charge and discharge it fully at least once a year. If you have more than 1 battery pack, perform these precautions at the same time for all battery packs.
 - Although the battery pack's operating temperature range is from 32° F to 104° F (0° C to 40° C), the optimal range is from 50° F to 86° F (10° C to 30° C). At cold temperatures, performance will temporarily decline. Warm it in your pocket before use.
 - Replace the battery pack if the usable time after full charge diminishes substantially at normal temperatures.

Installing the Backup Battery

The backup battery allows the camcorder to retain date, time and other camcorder settings while the power source is disconnected. Power the camcorder from a household power source or with a battery pack when replacing the backup battery to retain the setting.

E

1. Open the backup battery cover.
2. Insert the lithium battery with the + side facing outward.

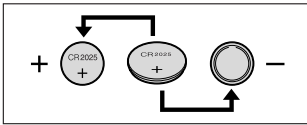

3. Close the cover.

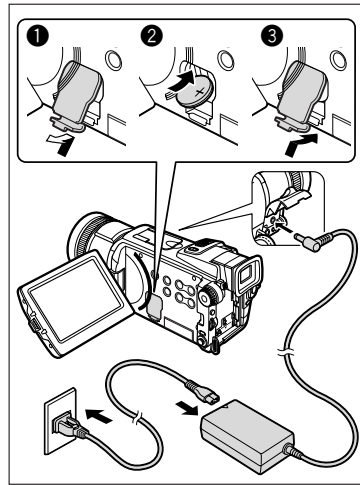

Mastering
the Basics

WARNING!

- The battery used in this device may present a fire or chemical burn hazard if mistreated. Do not recharge, disassemble, heat above 212° F (100° C) or incinerate the battery.
- Replace the battery with a CR2025 made by Panasonic, Hitachi Maxell, Sony, Sanyo, or with Duracell2025. Use of other batteries may present a risk of fire or explosion.



- Do not pick up the battery using tweezers or other metal tools as this will cause a short circuit.
- Wipe the battery with a clean dry cloth to ensure proper contact.
- Keep the battery out of reach of children. If it is swallowed, seek medical assistance immediately. The battery case may break and the battery fluids may damage stomach and intestines.
- Do not disassemble, heat or immerse the battery in water to avoid the risk of explosion.



The backup battery has a life span of about a year.  flashes in red to inform you that it needs to be replaced.

Preparing the Camcorder

E

Adjusting the Viewfinder (Diopter Adjustment)

1. Turn on the camcorder and keep the LCD panel closed.
2. Extend the viewfinder and move it upward.
3. Adjust the diopter adjustment lever.

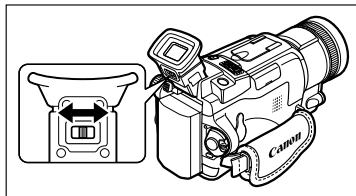

Do not leave the viewfinder exposed to direct sunlight as it may melt (due to concentration of light by the lens). Adjust the angle of the viewfinder to prevent sunlight from entering.

Attaching the Lens Hood

Attach the lens hood to shade the lens from stray light and to protect the lens.

1. Place the lens hood on the front of the lens.

Make sure that the lens hood is aligned with the thread.

2. Screw the lens hood clockwise on the lens.

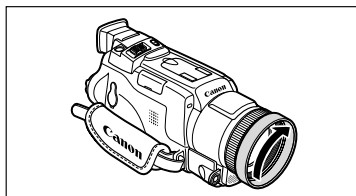

Attaching the Lens Cap

1. Attach the cord to the lens cap.
2. Pass the grip belt through the loop on the cord.

Press the buttons on the lens cap when attaching/removing it. Hook the lens cap on the grip belt while you are recording, and place it over the lens when you have finished.

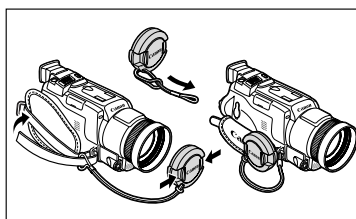

Fastening the Grip Belt

Hold the camcorder with your right hand and adjust the belt with your left.

Adjust the grip belt so that you can reach the zoom lever and photo button with your index finger, and the start/stop button with your thumb.

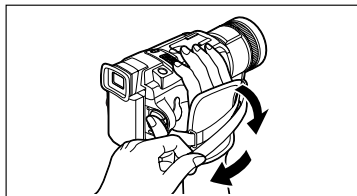

Attaching the Shoulder Strap

For extra security and portability, attach the shoulder strap before using the camcorder.

Pass the ends through the strap mount and adjust the length of the strap.

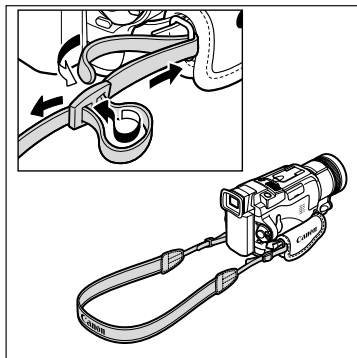

Removing and Attaching the Accessory Shoe Cover

Remove the accessory shoe cover when attaching an accessory to the advanced accessory shoe.

1. Lift the cover with your nail and remove the cover.

Hook the cover on the lens cap cord or grip belt while using the accessory shoe.

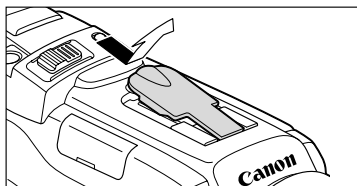

2. Insert the end into the accessory shoe and attach it onto the shoe.

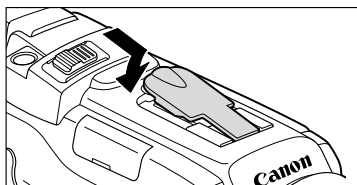

Loading a Cassette

E

Use only videocassettes marked with the ^{Mini} DV logo.

Loading and Unloading

1. Slide and hold the OPEN/EJECT switch and open the cassette compartment cover.

The cassette compartment opens automatically.

2. Load/unload the cassette.

- Load the cassette with the window facing the grip belt and the REC/SAVE tab facing upward.
- Unload the cassette by pulling it straight out.

3. Press the **PUSH** mark on the cassette compartment until it clicks.

Wait for the cassette compartment to retract automatically.

4. Close the cassette compartment cover.

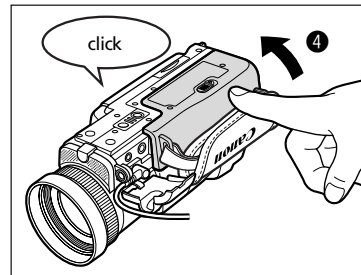
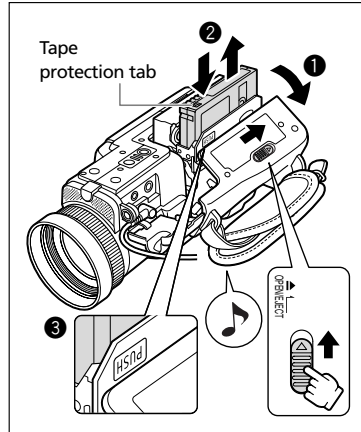

- Do not interfere with the cassette compartment while it is opening or closing automatically or attempt to close the cover until the cassette compartment has fully retracted.
- Be careful not to get your fingers caught in the cassette compartment cover.



- If the camcorder is connected to a power source, cassettes can be loaded/unloaded even if the POWER switch is set to OFF.
-  flashes in red if no cassette is inserted when turning on the power (in CAMERA and PLAY (VCR) mode).
- With some types of tapes, the remaining tape display may not be accurate.
- If the camcorder is mounted on a tripod, dismount the camcorder to open the cassette compartment.

Protecting Tapes from Accidental Erasure

To protect your recordings from accidental erasure, slide the tab on the cassette to the left. (This switch position is usually labeled SAVE or ERASE OFF)

If you load a protected cassette in CAMERA mode, the message "THE TAPE IS SET FOR ERASURE PREVENTION" appears for approx. 4 seconds and  starts flashing. If you wish to record on that cassette, slide the tab back to the right.

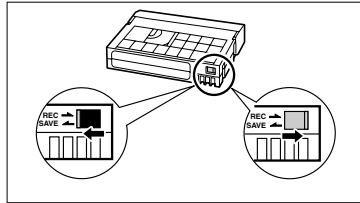

E

Cassette Handling Precautions

- Rewind tapes after use. If the tape becomes slack and damaged, it may cause picture and sound distortion.
- Return cassettes in the case and store them upright.
- Do not leave the cassette in the camcorder after use.
- Do not use spliced tapes or nonstandard cassettes as they may damage the camcorder.
- Do not use tapes that have been jammed as video heads may become dirty.
- Do not insert anything into the small holes of the cassette, or cover them with cellophane tape.
- Handle cassettes with care. Do not drop or subject them to severe impact as this may damage the cassettes.
- Rewind tapes from time to time if they are stored for a long time.
- With cassettes equipped with a memory function, metal plated terminals may become dirty with use. Clean the terminals with a cotton swab after about 10 times of loading/unloading. The memory function is not supported by the camcorder.

Mastering
the Basics

Using the Wireless Controller

E

You can operate the camcorder with the supplied wireless controller from a distance of up to 16 feet (5 m). Point it at the camcorder's remote sensor when you press the buttons.

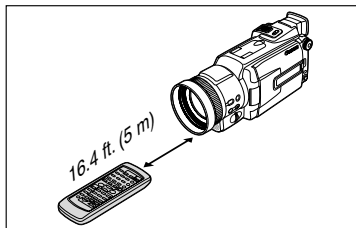

Following functions cannot be operated without the wireless controller:

- Some special playback modes (📖 38)
- Photo/date search (📖 94)
- Zero set memory (📖 95)
- AV Insert (📖 103)
- Audio dubbing (📖 105)
- 12 bit audio out/mix balance (📖 107)

Mastering
the Basics



- Camcorder and wireless controller are equipped with 2 remote sensor modes (📖 51). If the wireless controller does not work, check if camcorder and wireless controller are set to the same mode.
- The wireless controller may not work properly in bright places, such as outdoors under direct sunlight, or when used too close to the camcorder.
- The operable range of the wireless controller may shorten when the camcorder's remote sensor is exposed to strong light.
- When the batteries run out, replace both at the same time.

Inserting Batteries

The wireless controller operates with two AA batteries.

1. Open the battery cover.
2. Insert the batteries following the + and – markings.
3. Close the battery cover.

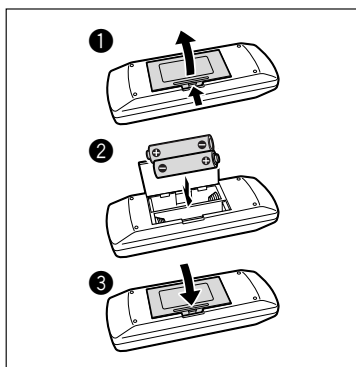

Setting the Time Zone, Date and Time

Set the time zone, date and time when you first start using your camcorder. Install the backup battery before you begin (📖 19).

E

Setting the Time Zone/Daylight Saving Time

CAMERA

PLAY (VCR)

CARD CAMERA

CARD PLAY (VCR)

MENU

(📖 43)

SYSTEM

T.ZONE/DST...N.Y.

1. Press the MENU button to open the menu.

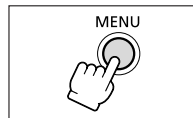

2. Turn the selector dial to select [SYSTEM] and press the selector dial.

3. Turn the selector dial to select [T.ZONE/DST] and press the selector dial.

- The time zone setting appears.
- The default setting is New York. Select your time zone and daylight saving time (DST) setting if necessary.

4. Turn the selector dial to select the setting option that represents your time zone.

To adjust for daylight saving time, select the time zone with the ☀ next to the area.

5. Press the MENU button to close the menu.

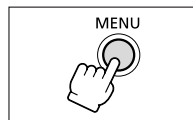

Mastering
the Basics

E

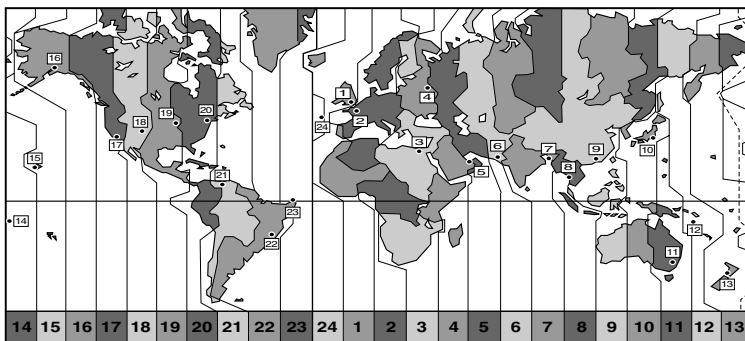

**Mastering
the Basics**

No.	Time zone	No.	Time zone
1	LONDON	13	WELLGTN (Wellington)
2	PARIS	14	SAMOA
3	CAIRO	15	HONOLU. (Honolulu)
4	MOSCOW	16	ANCHOR. (Anchorage)
5	DUBAI	17	L.A. (Los Angeles)
6	KARACHI	18	DENVER
7	DACCA	19	CHICAGO
8	BANGKOK	20	N.Y. (New York)
9	H. KONG (Hong Kong)	21	CARACAS
10	TOKYO	22	RIO (Rio de Janeiro)
11	SYDNEY	23	FERNAN. (Fernando de Noronha)
12	SOLOMON	24	AZORES



- Once you have set time zone, date and time, you do not need to reset the clock each time you travel to another time zone. Just set the time zone to the one of your destination, and the camcorder automatically adjusts the clock.
- Days per month and leap years will be automatically adjusted.

Setting the Date and Time

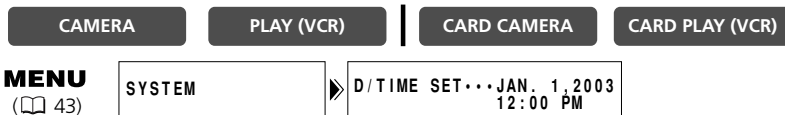

1. Press the MENU button to open the menu.

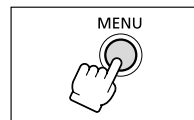

- 2. Turn the selector dial to select [SYSTEM] and press the selector dial.
- 3. Turn the selector dial to select [D/TIME SET] and press the selector dial.



The year display starts to flash.

- 4. Turn the selector dial to select the year, and press the selector dial.

- The next part of the display starts flashing.
- Set the month, day, hours and minutes in the same way.

- 5. Press the MENU button to close the menu and to start the clock.

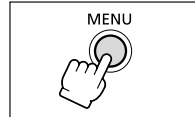

Time zone, date and time appear for 4 seconds each time you turn the power on.



- To change a part of the date or time, press the selector dial at step 4, and move to the part you wish to change.
- The date can be set to any year between 2003 and 2030.

Displaying Date and Time during Recording

You can display time zone, date and time in the lower left corner of the screen (the time zone disappears after 4 seconds). The 4-second display will no longer appear when you turn the power on. The date and time display will not be superimposed on your recordings.



- 1. Press the MENU button to open the menu.

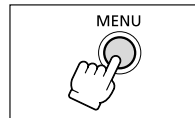

- 2. Turn the selector dial to select [DISPLAY SET UP] and press the selector dial.



- 3. Turn the selector dial to select [D/T DISPLAY] and press the selector dial.

- 4. Turn the selector dial to select [ON].

- 5. Press the MENU button to close the menu.

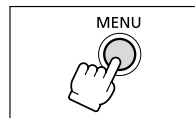

Recording Movies on a Tape



E

You can use the LCD screen or the viewfinder when recording. Adjust the angle of the LCD panel or viewfinder for comfortable recording.

Before You Begin Recording

Make a test recording first to check if the camcorder operates correctly. Before you make important recordings, clean the video heads ( 161).

Preparations

Connect a power source. Load a cassette.

Recording

1. Remove the lens cap.

2. Set the camcorder to CAMERA mode.

If you have not set the time zone, date and time, "SET THE TIME ZONE, DATE AND TIME" appears. See *Setting the Time Zone, Date and Time* ( 25).

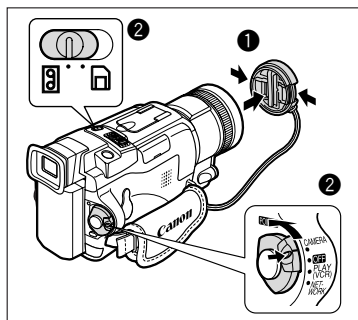

3. Open the LCD panel (32).

To use the viewfinder, keep the LCD panel closed or rotate it so that the screen faces in the same direction of the lens ( 33).

4. Press the start/stop button to begin recording.

Wait until the tape counter came to a complete stop before you begin recording.

5. Press the start/stop button again to pause recording.

Restart recording by pressing the start/stop button.

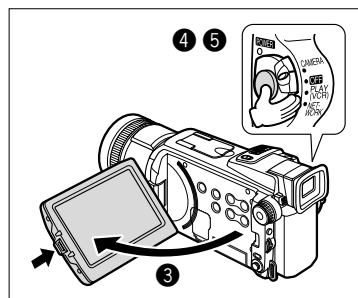

When You Have Finished Recording

1. Turn the **POWER** switch to **OFF**.
2. Close the LCD panel and return the viewfinder to its original position.
3. Replace the lens cap.
4. Unload the cassette.
5. Disconnect the power source.

E



When recording outdoors or through a window, do not leave LCD screen, viewfinder or lens exposed to direct sunlight as it may cause damage.



- Turn the power off if you do not intend to use the camcorder for a longer time.
- When you start recording, the camcorder counts from 1 second to 10 seconds (recording reminder). Recordings shorter than 10 seconds may be difficult to edit later. On the other hand, a recording not containing a particular action should generally last no longer than 10 seconds.
- The camcorder will shut off after 5 minutes when left in record pause mode to protect tape and video heads. “ AUTO POWER OFF” appears 20 seconds before shutoff. To continue recording, turn the POWER switch to OFF and then back to CAMERA.
- When you do not remove the cassette, you can record the next scene without producing any noise or blank sections between the recordings even if you turn the camcorder off.
- For extra recording time, see *Changing the Recording Mode* (📖 56).
- **About the LCD and viewfinder screen: The screens are produced with extremely high-precision manufacturing techniques, with more than 99.99% of the pixels operating to specification. Less than 0.01% of the pixels may occasionally misfire or appear as black or green dots. This has no effect on the recorded image and does not constitute a malfunction.**

Zooming



E

The camcorder's zoom lens allows you to choose the best picture angle for your recordings. The camcorder automatically switches between optical zooming and digital zooming. Image resolution is slightly lower with the digital zoom.

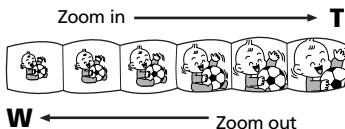

11× Optical Zoom (Card: 9×)

Move the zoom lever toward **W** to zoom out (wide-angle). Move it toward **T** to zoom in (telephoto).

- Press the zoom lever slightly for a slow zoom. Press harder for a faster zoom.
- You can also use the **T** and **W** buttons on the wireless controller. However, you cannot control the zoom speed.

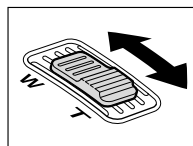

In the 16:9 mode, the optical zoom magnification is 10×.

44×/220× Digital Zoom (Card: 36×)

CAMERA

PLAY (VCR)

CARD CAMERA

CARD PLAY (VCR)

MENU

(43)

CAMERA SET UP

D. ZOOM.....44× (40×)

1. Press the **MENU** button to open the menu.

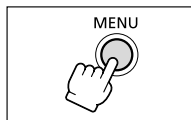

2. Turn the selector dial to select [CAMERA SET UP] and press the selector dial.



3. Select [D.ZOOM] and press the selector dial.

4. Select a setting option.

5. Press the **MENU** button to close the menu.

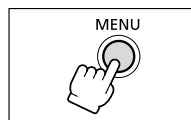



- Keep at least 3.3 ft. (1 m) to the subject. At wide-angle, you can focus on a subject as close as 0.79 in. (2 cm) in CAMERA mode and 2.4 in. (6 cm) in CARD CAMERA mode.
- A zoom indicator appears for 4 seconds. It extends in light blue when the digital zoom is set to 44x, and extends further in dark blue when set to 220x.
- Digital zoom cannot be used in the Night mode and Super Night mode.
- In the 16:9 mode, the digital zoom magnification is 40x/200x. It is shown in () in the menu.
- Digital zoom cannot be used when the multi-image screen is selected.

E

Using the LCD Screen

E

1. Push the OPEN button at the LCD panel and open the LCD panel.

The LCD screen switches on and the viewfinder switches off.

2. Rotate the LCD panel and choose the angle of the screen.

You can rotate the LCD panel so that the screen faces in the same direction as the lens (☐ 33), or push it flat against the camcorder with the screen facing outward.

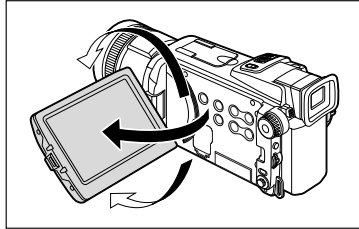

3. Close the LCD panel after use.

- Close the LCD panel firmly until it clicks.
- The LCD screen switches off and the viewfinder switches on.

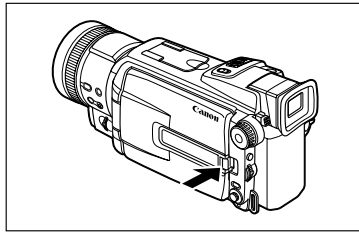

- Make sure to open the LCD panel at 90 degrees before rotating it.
- Rotate the LCD panel in the vertical position before closing the LCD panel.
- When recording outdoors or through a window, do not leave the LCD screen, viewfinder or lens exposed to direct sunlight as it may cause damage.
- Do not hold the camcorder by the LCD panel or the viewfinder.



- Bright light or reflected light may cause a vertical light bar to appear on the screen. This is not a malfunction.
- Bright light may make it difficult to use the LCD screen. In such case, use the viewfinder instead.

Adjusting the Brightness of the LCD Screen



CAMERA

PLAY (VCR)

CARD CAMERA

CARD PLAY (VCR)

MENU

(43)

DISPLAY SET UP

BRIGHTNESS ·····

E

1. Press the MENU button to open the menu.

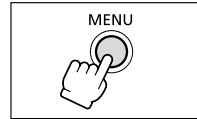

2. Turn the selector dial to select [DISPLAY SET UP] and press the selector dial.



3. Turn the selector dial to select [BRIGHTNESS] and press the selector dial.

4. Turn the selector dial and adjust the level.

Turn the selector dial up to make the screen brighter and down to make it darker.

5. Press the MENU button to close the menu.

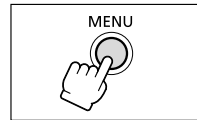

Changing the brightness of the LCD screen does not affect that of the viewfinder or the recordings.

Allowing the Subject to Monitor the LCD Screen

You can rotate the LCD panel so that the screen faces in the same direction as the lens. The viewfinder switches on allowing you to use the viewfinder while the subject can monitor the screen.

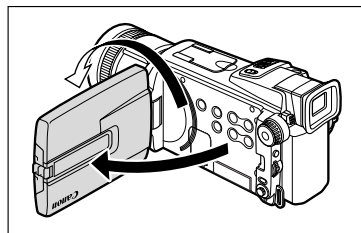

When you rotate the screen so that the screen faces in the same direction as the lens, the image appears mirror reversed (LCD MIRROR ON). However, you can choose to display the image as it is being recorded (LCD MIRROR OFF).

CAMERA

PLAY (VCR)

CARD CAMERA

CARD PLAY (VCR)

E

MENU

( 43)

DISPLAY SET UP

LCD MIRROR...ON

1. Press the MENU button to open the menu.

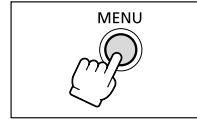

2. Turn the selector dial to select [DISPLAY SET UP] and press the selector dial.



3. Turn the selector dial to select [LCD MIRROR] and press the selector dial.

4. Turn the selector dial to select [OFF].

5. Press the MENU button to close the menu.

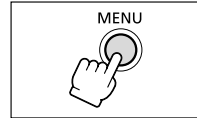

When [LCD MIRROR] is set to [ON], no displays appear on the LCD screen (they still appear on the viewfinder screen).

Searching and Reviewing when Recording

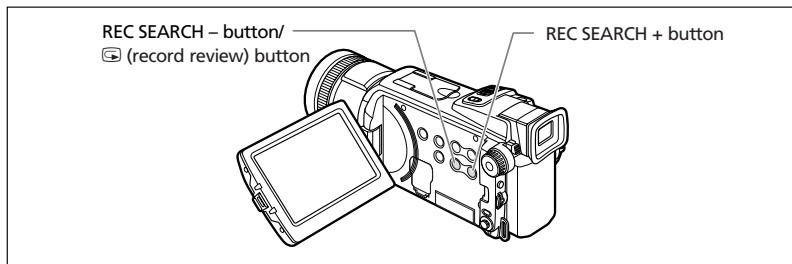

E

Record Review

CAMERA

PLAY (VCR)

CARD CAMERA

CARD PLAY (VCR)

In record pause mode, this function allows you to review the last few seconds of your recording to check if it has been recorded properly.

Press and release the (record review) button.

The camcorder rewinds the tape, plays back the last few seconds, and returns to record pause mode.

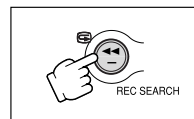

Record Search

CAMERA

PLAY (VCR)

CARD CAMERA

CARD PLAY (VCR)

In record pause mode, this function allows you to play back the tape (forward or reverse) to locate the point where you wish to begin recording.

Press and hold the REC SEARCH + button (forward) or - button (reverse).

- Release the button at the point you wish to begin recording.
- The camcorder returns to record pause mode.

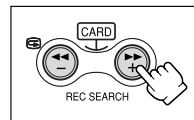

- Noise may appear on the screen when you play back the tape in reverse.
- There will be no sound during Record Review and Record Search.

Tips for Making Better Videos

E

Holding the Camcorder

For maximum stability, grip the camcorder in your right hand and keep your right elbow pressed against your body. If necessary, support the camcorder with your left hand. Be careful that your fingers do not touch the microphone or lens.

High-angle Recording

Low-angle Recording



Mastering the Basics

For More Stability

Lean against a wall

Put the camcorder on a table

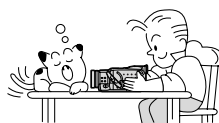

Lie on your elbow

Use a tripod



Lighting

When recording outdoors, we recommend recording with the sun at your back.

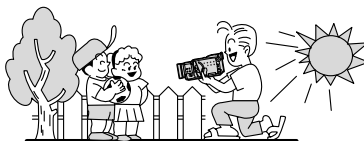

- When using a tripod, do not leave the viewfinder exposed to direct sunlight as it may melt (due to concentration of the light by the lens).
- Do not use tripods with fastening screws longer than 0.2 inch (5.5 mm) as it may damage the camcorder.

Playing Back a Tape



E

When you use the LCD screen for playback, the camcorder plays back the sound via built-in speaker. The built-in speaker is monaural. Use headphones for stereo sound or when using the viewfinder for playback.

Preparations

Connect a power source. Load a cassette.

Playback

1. Set the camcorder to PLAY (VCR) mode.

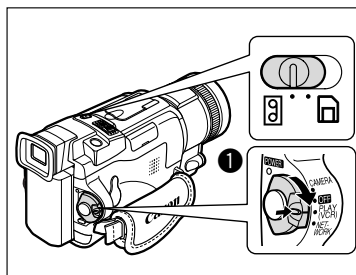

2. Open the LCD panel.

You can also close the LCD panel with the screen facing outward.

3. Press the ◀◀ button to rewind the tape.

To fast forward the tape, press the ▶▶ button.

4. Press the ▶/|| button to begin playback.

5. Press the ■ button to stop playback.

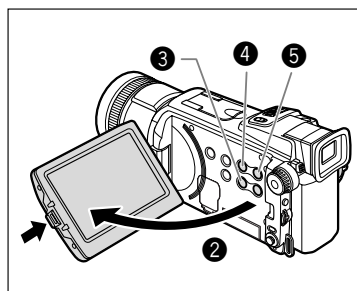

○ If the playback picture is distorted, clean the video heads using a Canon Head Cleaning Cassette or a commercially available digital video head-cleaning cassette (□ 161).

○ To use the viewfinder, close the LCD panel. The built-in speaker does not sound. Use headphones when using the viewfinder (□ 39).

○ You can display the audio level indicator by pressing the AUDIO LEVEL button.

○ For displaying the date and time during playback, see *Displaying the Data Code* (□ 92).

Special Playback Modes

Special playback modes (except of playback pause and fast/rewind playback) can only be operated with the wireless controller.

E

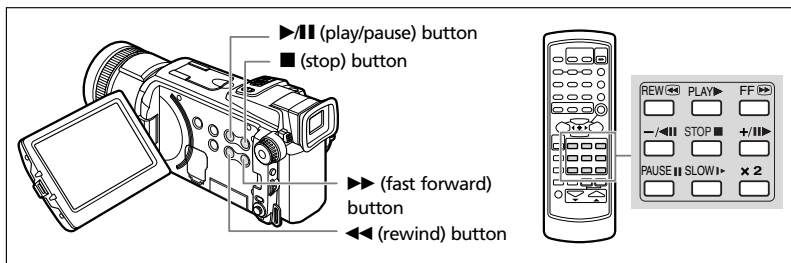

▶/|| (Playback Pause)

To pause playback, press the ▶/|| button. Press the ▶/|| button to resume playback. The camcorder goes into stop mode after 5 minutes in playback pause mode.

▶▶ (Fast Forward Playback) / ◀◀ (Rewind Playback)

Plays back the tape at 9.5 times normal speed (forward or reverse). Press and hold the button during normal playback or fast forward.

+/||▶ (Frame Advance) / -/◀|| (Frame Reverse)

Plays back frame-by-frame. Press the button repeatedly during playback pause. Press and hold it to play back continuous frame advance/frame reverse.

SLOW ▶ (Slow Forward)/(Slow Reverse)

Plays back at about 1/3 normal speed. For slow forward playback, press the SLOW ▶ button. For slow reverse playback, press the -/◀|| button followed by the SLOW ▶ button. Press the ▶ (play) button to return to normal playback.

-/◀|| (Reverse Playback)

Plays back in reverse at normal speed. Press the button during normal playback. Press the ▶ (play) button return to normal playback. The camcorder goes into stop mode after 5 minutes in reverse playback pause.

× 2 (Forward× 2 Playback)/(Reverse 2× Playback)

Plays back at 2 times normal speed. Press the button during normal or reverse playback. Press the ▶ (play) button return to normal playback.



- There is no sound during special playback.
- The picture may become distorted during some special playback modes.

Playing Back with the Built-in Speaker/Headphones

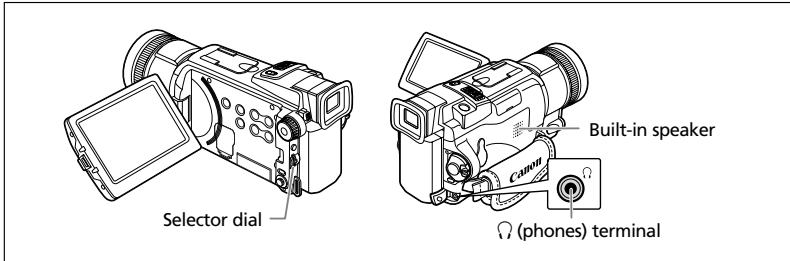

F



- The built-in speaker does not sound when you use headphones.
- The built-in speaker is monaural. Use headphones for stereo sound.

Adjusting the Volume

CAMERA

PLAY (VCR)

CARD CAMERA

CARD PLAY (VCR)

Turn the selector dial up to increase the volume, and down to lower the volume.

- A volume bar appears for 4 seconds.
- You can turn off the volume completely by turning the selector dial down until [OFF] appears. Turn the selector dial up to increase the volume again.



- Sound may become distorted when the volume is turned up too high.
- The camcorder retains the setting even if you turn it off (separately for headphones and built-in speaker).
- See also *Using Headphones during Recording* (📖 77).

Mastering
the Basics

Playing Back on a TV Screen

E

You can connect the camcorder to a TV or VCR to play back your recordings on a TV screen.



When you use the TV as a monitor during recording, keep the TV volume turned down as long as the camcorder's audio terminals are connected. An unpleasant high-pitched squeal, called feedback, may be produced if sound from the TV speakers is picked up by the microphone.



- For high picture quality, we recommend using a TV with an S (S1) terminal.
- TVs with S1-terminal or Video ID-1 system: Recordings made in the 16:9 mode (□ 54) will be automatically played back in wide screen mode.

TVs with S (S1)-Video Input Terminal

Refer also to the TV or VCR instruction manual.

Mastering
the Basics

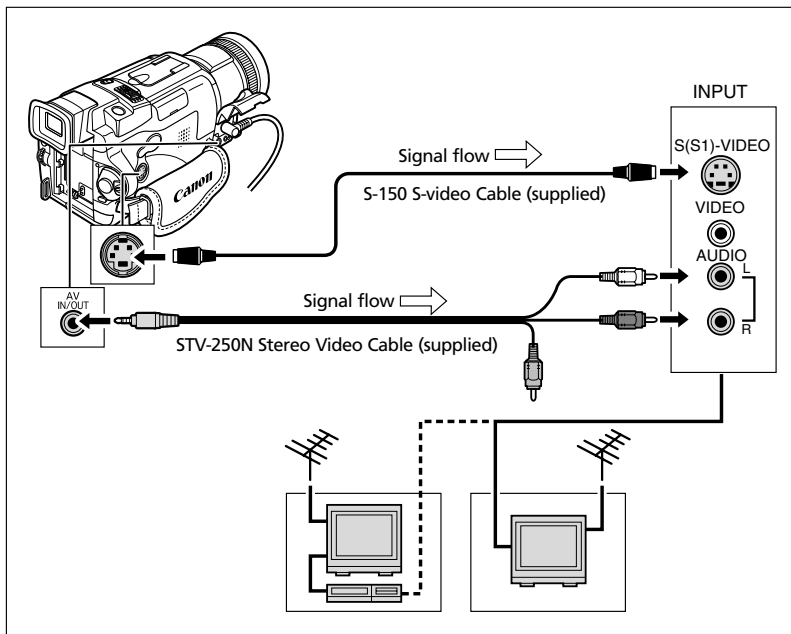

1. Turn off all devices before starting the connections.
2. Connect the S-150 S-video Cable to the S-video terminals.

3. Connect the STV-250N Stereo Video Cable to the camcorder's AV terminal and the audio terminals of the TV/VCR.

Connect the white plug to the white AUDIO terminal L (left), and the red plug to the red AUDIO terminal R (right). Do not connect the yellow plug.

4. If connecting to a TV, set the input selector to VIDEO. If connecting to a VCR, set the input selector to LINE.

TVs with Audio/Video Terminals

Refer also to the TV or VCR instruction manual.

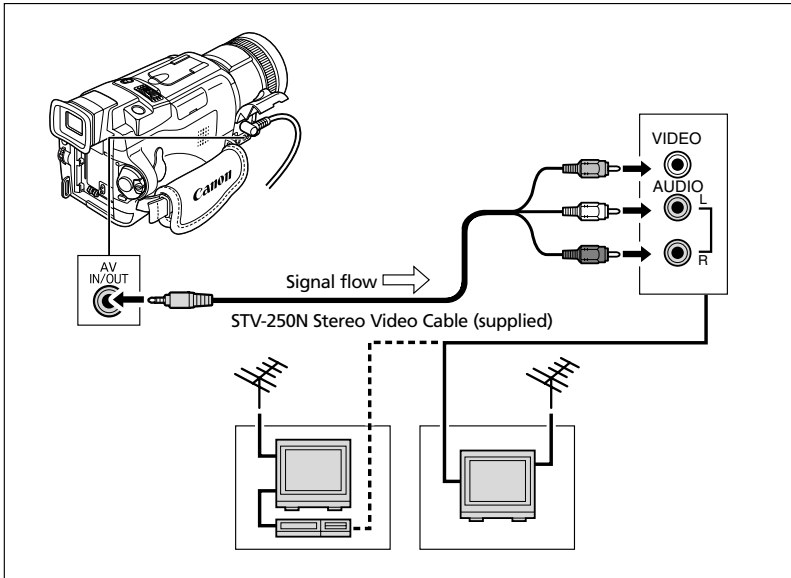

1. Turn off all devices before starting the connections.

2. Connect the STV-250N Stereo Video Cable to the camcorder's AV terminal and the audio/video terminals on the TV/VCR.

Connect the white plug to the white audio terminal L (left), the red plug to the red audio terminal R (right) and the yellow plug to the yellow video terminal VIDEO.

3. If connecting to a TV, set the input selector to VIDEO. If connecting to a VCR, set the input selector to LINE.

Selecting the Audio Output Channel



You can select the output channels when playing back a tape with audio recorded on two channels.

E

CAMERA

PLAY (VCR)

CARD CAMERA

CARD PLAY (VCR)

MENU

(43)

AUDIO SET UP

▶ OUTPUT CH...L/R

1. Press the **MENU** button to open the menu.

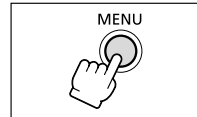

2. Turn the selector dial to select **[AUDIO SET UP]** and press the selector dial.



3. Turn the selector dial to select **[OUTPUT CH]** and press the selector dial.

4. Turn the selector dial to select a setting option.

- L/R: Stereo: L+R channels, Bilingual: Main+Sub.
- L/L: Stereo: L channel, Bilingual: Main.
- R/R: Stereo: R channel, Bilingual: Sub.

5. Press the **MENU** button to close the menu.

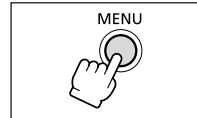

The setting resets to the L/R setting when you turn the camcorder off.

Menus and Settings



Many of the camcorder's advanced functions are selected from menus that appear on the screen.

E

Selecting Menus and Settings

1. Set the camcorder to the correct operating mode.

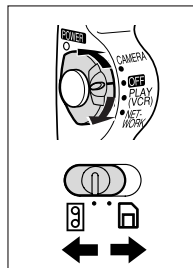

2. Press the MENU button to open the menu.

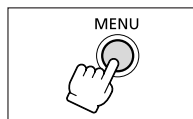

3. Turn the selector dial to select a submenu and press the selector dial.



4. Turn the selector dial to select a menu item and press the selector dial.

5. Turn the selector dial to select a setting option.

6. Press the MENU button to close the menu.

When setting the white balance, press the selector dial first before pressing the MENU button.

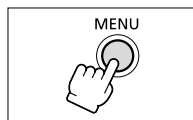

- Pressing the MENU button at any time closes the menu.
- Selecting [← RETURN] takes you back one level.
- When the submenu consists of 2 pages, select [NEXT PAGE] to move to the second page, and [PREV PAGE] to return to the first page.
- Items that are not available appear in purple.
- You may find it more convenient to use the wireless controller to operate the menu. Press the MENU button on the wireless controller to open or close the menu. Use the select buttons in place of the selector dial and press the SET button in place of pressing the selector dial.

Using the Full Range
of Features

Menu and Default Settings

Default settings are shown in boldface.

CAMERA Menu (CAM. MENU)

E

CAMERA





PLAY (VCR)

CARD CAMERA

CARD CAMERA

Submenu	Menu Item	Setting Options	
→CARD MIX	MIX TYPE	CARD CHROMA , CARD LUMI., CAM. CHROMA, C. ANIMATION	133
	ANIMAT. TYPE	CORNER , STRAIGHT, RANDOM	133
	MIX LEVEL		133
CAMERA SET UP	D. ZOOM	OFF, 44x (40x) , 220x (200x)	30
	IMAGE S. (👉)*	ON , OFF	73
	WHITE BAL.	AUTO , SET 📷, INDOOR 🏠, OUTDOOR *	89
	AF AST LAMP	AUTO , OFF	60
	16:9	ON, OFF	54
	PHOTO REC	TAPE 📼, CARD 📷	114
	ZEBRA*	ON, OFF	85
	BLC*	ON, OFF	85
VCR SET UP	REC MODE	SP , LP	56
AUDIO SET UP	WIND SCREEN	ON, OFF	77
	MIC ATT	ON, OFF	76
	MIC LEVEL	AUTO , MANUAL	75
	AUDIO MODE	16bit, 12bit	75
	🔊 VOLUME		77
DISPLAY SET UP	BRIGHTNESS		33
	LCD MIRROR	ON , OFF	33
	TV SCREEN	ON , OFF	153
	D/T DISPLAY	ON, OFF	27
	DEMO MODE	ON , OFF	55

* Function that can be assigned to the custom key.

Submenu	Menu Item	Setting Options	
SYSTEM	CUSTOM KEY	OFF, IMAGE S., BLC, ZEBRA	53
	WL. REMOTE	 1,  2, OFF 	51
	TALLY LAMP	ON, OFF	54
	BEEP	ON, OFF	54
	T.ZONE/DST	See list of time zones	25
	D/TIME SET		26
MY CAMERA	S-UP SOUND	OFF, DEFAULT , MY SOUND1, MY SOUND2	52
	SHTR SOUND	OFF, DEFAULT , MY SOUND1, MY SOUND2	52
	OPER. SOUND	OFF, DEFAULT , MY SOUND1, MY SOUND2	52
	SELF-T SOUND	OFF, DEFAULT , MY SOUND1, MY SOUND2	52

E

Using the Full Range
of Features

PLAY (VCR) Menu (VCR MENU)

CAMERA

PLAY (VCR)

CARD CAMERA

CARD CAMERA

E

Submenu	Menu Item	Setting Options	
VCR SET UP	REC MODE	SP, LP	56
	AV → DV OUT	ON, OFF	101
AUDIO SET UP	OUTPUT CH	L/R, L/L, R/R	42
	AUDIO DUB.	AUDIO IN, MIC. IN	105
	WIND SCREEN	ON, OFF	77
	MIC ATT	ON, OFF	76
	MIC LEVEL	AUTO, MANUAL	75
	AUDIO MODE	16bit, 12bit	75
	CARD SET UP	SI QUALITY	SUPER FINE, FINE, NORMAL
MOVIE SIZE		352 × 288, 176 × 144	111
FILE NOS.		RESET, CONTINUOUS	111
CARD OPERATIONS	COPY [COPY] → [OK]	CANCEL, EXECUTE	136
DISPLAY SET UP	BRIGHTNESS		33
	DISPLAYS	ON, OFF <PLAYBK>	153
	6SEC. DATE	ON, OFF	93
	DATA CODE	DATE/TIME, CAMERA DATA, CAM. & D/T	93
	D/TIME SEL.	DATE, TIME, DATE & TIME	93
SYSTEM	WL. REMOTE	[[1], [[2], OFF [[3]	51
	TALLY LAMP	ON, OFF	54
	BEEP	ON, OFF	54
	T.ZONE/DST	See list of time zones	25
	D/TIME SET		26

Submenu	Menu Item	Setting Options	
MY CAMERA	S-UP SOUND	OFF, DEFAULT, MY SOUND1, MY SOUND2	52
	SHTR SOUND	OFF, DEFAULT, MY SOUND1, MY SOUND2	52
	OPER. SOUND	OFF, DEFAULT, MY SOUND1, MY SOUND2	52
	SELF-T SOUND	OFF, DEFAULT, MY SOUND1, MY SOUND2	52

E

**Using the Full Range
of Features**

CARD CAMERA Menu (C. CAM. MENU)





CAMERA

PLAY (VCR)





CARD CAMERA

CARD PLAY (VCR)

E

Submenu	Menu Item	Setting Options	
CAMERA SET UP	D.ZOOM	OFF, 36×	30
	IMAGE S. (M)*	ON, OFF	73
	WHITE BAL.	AUTO, SET  , INDOOR  , OUTDOOR *	89
	DRIVE MODE*	CONT.  , AEB  , SINGLE	119
	AF AST LAMP	AUTO, OFF	60
	FOCUS PRI.	ON, OFF	118
	ND	AUTO, OFF	114
	ZEBRA*	ON, OFF	85
	BLC*	ON, OFF	85
CARD SET UP	SI QUALITY	SUPER FINE, FINE, NORMAL	110
	SI SIZE	1632 × 1224, 1280 × 960, 640 × 480	110
	MOVIE SIZE	352 × 288, 176 × 144	111
	FILE NOS.	RESET, CONTINUOUS	111
AUDIO SET UP	WIND SCREEN	ON, OFF	77
	MIC ATT	ON, OFF	76
	 VOLUME		77
DISPLAY SET UP	BRIGHTNESS		33
	LCD MIRROR	ON, OFF	33
	TV SCREEN	ON, OFF	153
	D/T DISPLAY	ON, OFF	27
	DEMO MODE	ON, OFF	55

* Function that can be assigned to the custom key.

Submenu	Menu Item	Setting Options	
SYSTEM	CUSTOM KEY	OFF, IMAGE S., BLC, ZEBRA, DRIVE MODE	53
	WL. REMOTE	 1,  2, OFF 	51
	TALLY LAMP	ON, OFF	54
	BEEP	ON, OFF	54
	T.ZONE/DST	See list of time zones	25
	D/TIME SET		26
MY CAMERA	S-UP SOUND	OFF, DEFAULT , MY SOUND1, MY SOUND2	52
	SHTR SOUND	OFF, DEFAULT , MY SOUND1, MY SOUND2	52
	OPER. SOUND	OFF, DEFAULT , MY SOUND1, MY SOUND2	52
	SELF-T SOUND	OFF, DEFAULT , MY SOUND1, MY SOUND2	52

E

Using the Full Range of Features

CARD PLAY (VCR) Menu (C.PLAY MENU)

CAMERA

PLAY (VCR)

CARD CAMERA

CARD PLAY (VCR)

E

Submenu	Menu Item	Setting Options	
CARD OPERATIONS (Single Image Display)	COPY [→]	CANCEL, EXECUTE	137
	PRINT ORDERS ALL ERASE	YES, NO	131
	IMAGE ERASE	CANCEL, SINGLE, ALL	129
	FORMAT	CANCEL, EXECUTE	138
CARD OPERATIONS (Index Screen)	→ PROTECT		128
	→ PRINT ORDER		130
VCR SET UP	REC MODE	SP, LP	56
DISPLAY SET UP	BRIGHTNESS		33
	DISPLAYS	ON, OFF <PLAYBK>	153
	D/TIME SEL.	DATE, TIME, DATE & TIME	93
SYSTEM	WL. REMOTE	1, 2, OFF	51
	TALLY LAMP	ON, OFF	54
	BEEP	ON, OFF	54
	USB CONNECT	STANDARD, STORAGE	139
	T.ZONE/DST	See list of time zones	25
	D/TIME SET		26
MY CAMERA	SEL. S-UP IMG	NO IMAGE, CANON LOGO, MY IMAGE1, MY IMAGE2	52
	S-UP SOUND	OFF, DEFAULT, MY SOUND1, MY SOUND2	52
	SHTR SOUND	OFF, DEFAULT, MY SOUND1, MY SOUND2	52
	OPER. SOUND	OFF, DEFAULT, MY SOUND1, MY SOUND2	52
	SELF-T SOUND	OFF, DEFAULT, MY SOUND1, MY SOUND2	52
→ PRINT	Appears when connecting a printer with direct print function.		151

Shaded area : Only available in still image playback mode.

Changing the Remote Sensor Mode



Two remote sensor modes and an off setting are available to prevent interference from other Canon wireless controllers being used nearby.

E

Turning the Remote Sensor Off



MENU

(43)

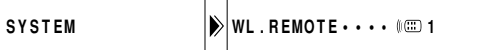

Open the menu and select [SYSTEM]. Select [WL. REMOTE], set it to [OFF ()] and close the menu.

“(OFF)” appears.



Changing the Remote Sensor Mode



MENU

(43)

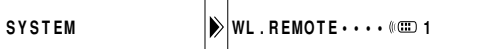

1. On the camcorder, open the menu and select [SYSTEM]. Select [WL. REMOTE], set it to [2] and close the menu.

The selected mode appears for 4 seconds.

2. On the wireless controller, press and hold the REMOTE SET button. Press the ZOOM T button for mode 2. Keep the button pressed for over 2 seconds.

If you have set the camcorder to mode 1, press the ZOOM W button for mode 1.

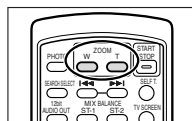
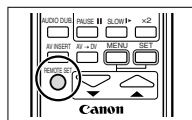

- The wireless controller returns to mode 1 when you replace the batteries. Change the mode if necessary.
- Make sure that camcorder and wireless controller are set to the same mode. Display the camcorder's mode by pressing any button on the wireless controller (except of the REMOTE SET button) and set the wireless controller's mode to the same mode. Change the batteries if the wireless controller still does not work.

Using the Full Range of Features

Customizing the Camcorder



E

You can personalize your camcorder by customizing the start-up image and the sound it makes for start-up, shutter, operation and self-timer (collectively called the My Camera settings).



- The start-up image can only be selected in CARD PLAY (VCR) mode.
- You can save your original images, or the images and sounds contained in the supplied software (ZoomBrowser EX for Windows or ImageBrowser for Macintosh) to the setting options [MY IMAGE1], [MY IMAGE2], [MY SOUND1] and [MY SOUND2]. For details, refer to the Digital Video Software Instruction Manual.

Changing the My Camera Settings

CAMERA

PLAY (VCR)

CARD CAMERA

CARD PLAY (VCR)

MENU

(43)

MY CAMERA

SEL . S-UP IMG . CANON LOGO

S-UP SOUND . . . DEFAULT

SHTR SOUND . . . DEFAULT

OPER . SOUND . . . DEFAULT

SELF-T SOUND . DEFAULT

Using the Full Range
of Features

1. Open the menu and select [MY CAMERA].
2. Select the menu item you wish to change.
 - When selecting a start-up image (only in CARD PLAY (VCR) mode): [NO IMAGE], [CANON LOGO], [MY IMAGE1] and [MY IMAGE2] appears.
 - When selecting a sound: [OFF], [DEFAULT], [MY SOUND1] and [MY SOUND2] appear.
3. Select a setting option and close the menu.

Using the Custom Key

You can assign the following functions to the CSTM KEY, independently for CAMERA and CARD CAMERA mode.

E

CAMERA Mode	CARD CAMERA Mode
Image Stabilizer (📖73)	Image Stabilizer (📖73)
Backlight Compensation (📖85)	Backlight Compensation (📖85)
Zebra Pattern (📖85)	Zebra Pattern (📖85)
	Drive Mode (📖119)

Assigning a Function to the CSTM KEY



Open the menu and select [SYSTEM]. Select [CUSTOM KEY], select a setting option and close the menu.

The name of the selected function appears on the screen.

Using the CSTM KEY Button



When set to image stabilizer, backlight compensation or zebra pattern, press the CSTM KEY to activate the function. Press it again to deactivate the function.

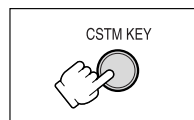

When set to drive mode, press the CSTM KEY to switch between the drive modes.

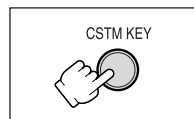

The setting changes with each press of the button:

No display (single) → 📷 (continuous shooting) → 📷 (auto exposure bracketing)



Other Camcorder Settings



E

Beep

You will hear a beep upon camcorder operations such as power on/off, start/stop, self-timer countdown, automatic shut-off, and unusual conditions of the camcorder. The beep will not be recorded.

If you turn off the beep, all camcorder sounds including the ones of the My Camera settings will be turned off.

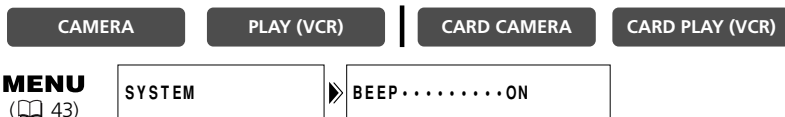

To turn the beep off, open the menu and select [SYSTEM]. Select [BEEP], set it to [OFF] and close the menu.

Turning Off the Tally Lamp

The tally lamp indicates that the camcorder is recording, receiving signals from the wireless controller or counting down for the self-timer. However, the flashing may be reflected in the lens when recording close-ups or through glass, and you may therefore decide to turn it off.

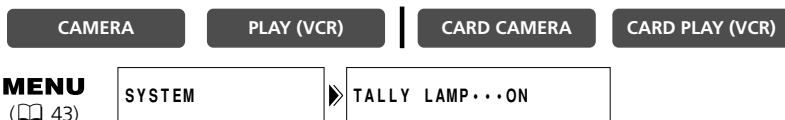

Open the menu and select [SYSTEM]. Select [TALLY LAMP], set it to [OFF] and close the menu.

The tally lamp still lights up when the camcorder receives a signal from the wireless controller, or during self-timer countdown.

Recording in 16:9 (Wide Screen TV Recording)

You can record in the 16:9 format for playback on wide screen TVs.

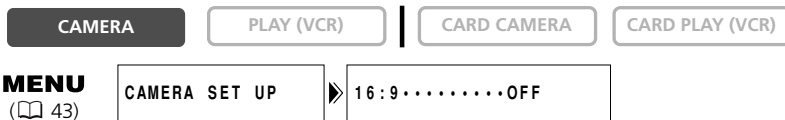

To switch 16:9 on, open the menu and select [CAMERA SET UP]. Select [16:9], set it to [ON] and close the menu.

"16:9" appears.



- The 16:9 mode is an electronically processed effect.
- The 16:9 mode cannot be selected in the Easy Recording mode.
- Still images cannot be recorded when the 16:9 format is selected.
- Multi-image screen and card mix function cannot be used when the 16:9 format is selected.
- If you play back a 16:9 recording on a normal TV, the image appears vertically "squashed" (compressed).
- If you connect the camcorder to a TV with an S1 terminal or Video ID-1 system, recordings made in the 16:9 mode will be automatically played back in wide screen mode.

Demonstration Mode

The demonstration mode displays the camcorder's main features. It starts automatically when you leave the camcorder turned on without loading a cassette and without inserting a memory card for more than 5 minutes. However, you can set the camcorder to not start the demonstration mode.

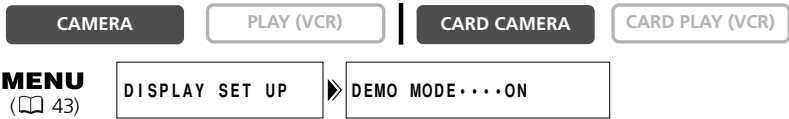

With no cassette and memory card inserted, open the menu and select [DISPLAY SET UP]. Select [DEMO MODE], set it to [OFF] and close the menu.



To cancel the demo mode once it has begun, press any button, turn off the camcorder, load a cassette or insert a memory card.

Changing the Recording Mode (SP/LP)

E

You can choose from SP (standard play) and LP (long play). LP extends the tape usage by 1.5 times.



- Tapes recorded in LP mode cannot be used for audio dubbing (📖 105) or AV insert (📖 103).
- Depending on the nature and usage condition of the tape, picture and sound recorded in LP mode may be distorted. We recommend using the SP mode for important recordings.
- We recommend recording in SP mode if you plan to transfer the images to a computer.
- If you record in both SP and LP modes on the same tape, the playback picture may become distorted and the time code may not be written correctly.
- If you play back a tape that has been recorded in LP mode with another digital device on this camcorder, or vice versa, picture and sound may become distorted.

CAMERA

PLAY (VCR)

CARD CAMERA

CARD PLAY (VCR)

MENU

(📖 43)

VCR SET UP



▶ REC MODE.....SP

To change to LP mode, open the menu and select [VCR SET UP]. Select [REC MODE], set it to [LP] and close the menu.

Recording Still Images on the Tape

Starting your recording with a still image allows you to easily locate the beginning of the recording with the Photo Search function ( 94).

You can also record still images on a memory card while recording movies on a tape ( 114).

 Open the menu and select [CAMERA SET UP]. Select [PHOTO REC], confirm that [TAPE ] is selected and close the menu.

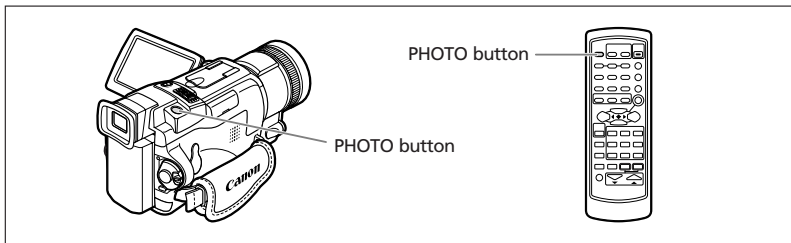

CAMERA

PLAY (VCR)

CARD CAMERA

CARD PLAY (VCR)

In Record Pause Mode

1. Press the PHOTO button halfway.

-  appears in green. If it does not appear in green, adjust the focus with the focus ring.
- Focus can be adjusted manually with the focus ring when the PHOTO button is pressed halfway.
- Exposure is locked.
- When you press the PHOTO button on the wireless controller, recording starts immediately.

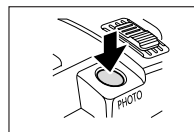

2. Press the PHOTO button fully.

-  disappears.
- The camcorder records the still image for approx. 6 seconds. During this time, the camcorder displays the still image and keeps recording the sound.
- The camcorder returns to record pause mode.

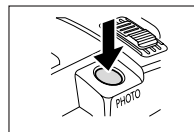

Using the Full Range
of Features

During Recording

1. Press the PHOTO button fully.

- The camcorder records the still image for approx. 6 seconds. During this time, the camcorder displays the still image and keeps recording the sound.
- The camcorder returns to record pause mode.

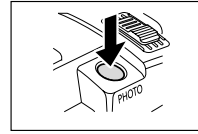

- When you turn the POWER switch to OFF while the camcorder is recording the still image, it will not turn off until recording is complete.
- Record still images under sufficient lighting condition (in which you can identify the subject on the screen).

Using the Built-in Flash



You can use the built-in flash for recording still images.

E

(flash auto)	The flash fires automatically according to the brightness of the subject.
(red-eye reduction, auto)	The flash fires automatically according to the brightness of the subject, and the assist lamp lights up to reduce the red-eye effect.
(flash on)	The flash always fires.
(flash off)	The flash does not fire. Use this setting in places where flash photography is prohibited.

CAMERA

PLAY (VCR)

CARD CAMERA

CARD PLAY (VCR)

1. Press the (flash) button.

- The setting changes with each press of the button.
- The symbol of the selected flash mode appears on the screen. “” disappears after 4 seconds.

2. Press the PHOTO button halfway.

- The flash automatically rises.
- “” appears in green.

3. Press the PHOTO button fully.

The flash fires and the still image shown on the screen will be recorded.

4. After use, return the flash to the body by pressing the flash down.







Do not return the flash while it is firing.



- Do not fire the flash close to people's eyes.
- Do not fire the flash at persons while they are driving.
- Do not fire the flash with the flash bulb covered with your hand.



- The practical range of the flash is approx. 3.3 to 9.2 ft. (1 to 2.8 m). The range depends upon the recording condition.
- The camcorder fires a pre-flash to obtain the subject's exposure data and adjusts the main flash to the optimal intensity (flash exposure compensation).
- The effect of flash photography may not be obtained in bright places.
- For the red-eye reduction mode to be effective, the subject needs to look at the assist-lamp. The degree of reduction depends upon the distance and on each individual.
- The red-eye reduction mode cannot be used in stitch assist mode.
- The flash mode cannot be selected when exposure is locked, or after the first still image in Stitch Assist mode.

- The flash will not fire in the following cases:
 - When you lock the exposure by pressing the EXP dial in  (auto) or  (red-eye reduction, auto) mode.
 - When the shutter speed is set to 1/2000 in Tv mode in CAMERA mode. However, if  (flash on) is selected, the shutter speed becomes set to 1/1000 and the flash fires.
 - When an abnormality occurs during charging (the flash mark flashes in red).
 - When the multi-image screen is selected or when you are recording movies onto a tape (no flash mark appears).
 - When the flash mark does not appear in green when you press the PHOTO button. Set it to  (flash on) if necessary.
- When the flash is fired with an accessory such as a lens hood or an optional wide-converter attached to the camcorder, its shadow may be recorded.
- An image recorded with flash may flicker when played back on a different device.
- If you attach the optional VFL-1 Video Flash Light ( 79) and set it to  ON, the Video Flash Light fires in place of the built-in flash.

AF-Assist Lamp



The AF-assist lamp (White LED) illuminates the subject in the center of the screen to enable the camcorder to focus in dark places (under the same conditions in which the flash fires in  (auto) mode).

CAMERA

PLAY (VCR)

CARD CAMERA

CARD PLAY (VCR)

1. Set the flash to a mode other than  (flash off) ( 59).
2. Keep the PHOTO button pressed halfway and turn the focus ring.

- The AF- assist lamp lights up in dark lighting condition.
- In CARD CAMERA mode, the AF-assist lamp lights up during autofocus or manual focus while the PHOTO button is pressed halfway when [FOCUS-PRI.] is set to [ON].

The AF-assist lamp turns off after a short time.



- The camcorder may not be able to focus even though the AF-assist lamp is lighting. In such case, adjust the focus manually.
- The AF-assist lamp lights up brightly. Consider turning off the AF-assist lamp in public places such as in restaurants or theaters.
- Turn off the AF-assist lamp in places where flash photography is prohibited.
- If you have attached the optional VFL-1 Video Flash Light, set it to  ON.
- The assist lamp does not light up in situations in which the flash does not fire.

Turning Off the AF-Assist Lamp



E

To turn off the AF-assist lamp, open the menu and select [CAMERA SET UP]. Select [AF AST LAMP], set it to [OFF] and close the menu.

Using the Recording Programs



E

The camcorder is equipped several program AE modes. The availability of functions differs depending on the selected mode.

Availability of Functions in Each Mode:

Position of the Mode Dial	<input type="checkbox"/>	A	Tv	Av				
Digital Zoom				○				×
Image Stabilizer	ON							○
Focus	A							○
Exposure	A							○
White Balance	A							○
Shutter Speed		A	○					A
Aperture		A		○				A
Zebra Pattern	×							○
Backlight Compensation	×							○
Digital Effects	×							○*
16:9	×							○
Card Mix**	×							○
Custom Key	×							○
Microphone Attenuator	×							○
Microphone Level	×							○

A: Auto setting ○: Available ×: Not available

Shaded area: Can be used only when the TAPE/CARD switch is set to

* : Only Black and White can be used in CARD CAMERA mode. The multi-image screen cannot be used in Night and Super Night mode.

** : Card mix can only be used when [PHOTO REC] is set to [TAPE] (132).

Easy Recording

The camcorder adjusts focus, exposure and other settings automatically, allowing you to just point and shoot.



A Auto

The camcorder adjusts focus, exposure and other settings automatically. However, you have the option of adjusting the settings manually.



Using the Full Range of Features

Tv Shutter-Priority Mode

Use this mode to select the shutter speed (📖 86). Use a high shutter speed for recording sports scenes (such as tennis or golf) or moving subjects (such as roller coasters). Use a slow shutter speed when recording in dimly lit places, or to create a trailing effect.



E

Av Aperture-Priority Mode

Use this mode to select the aperture (📖 88). Control the depth of field to give accent to your subject by blurring the background or the foreground.



🔦 Spotlight

Use this mode to record spotlight scenes such as shows, recitals or fireworks.



🏖️ Sand & Snow

Use this mode in bright places such as a sunny beach or ski resort. It prevents the subject from being underexposed.

- The subject may become overexposed in dark surroundings. Check the image on the screen.
- This mode is set at a higher shutter speed. The picture may not appear smooth when played back.



🌙 Night

Use this mode to record in dark places. The shutter speed is adjusted automatically. It is useful when recording in places with changing light conditions (such as in amusement parks).

- Moving subjects may leave a trailing afterimage.
- Picture quality may not be as good as in other modes.
- White points may appear on the screen.
- Autofocus may not work as well as in other modes. In such case, adjust the focus manually.



Using the Full Range of Features

Super Night

Use this mode to record in very dark places. The shutter speed is adjusted automatically. The assist lamp (White LED) lights up automatically responding to the surrounding brightness and illuminates the subject in the center of the screen.



- The range of the assist lamp is limited. Check the image on the screen when recording.
- Use this mode for recordings at close range (up to 6.6 ft (2m)).
- Moving subjects may leave a trailing afterimage.
- Picture quality may not be as good as in other modes.
- White points may appear on the screen.
- Autofocus may not work as well as in other modes. In such case, adjust the focus manually.

Selecting the Program AE Mode

CAMERA

PLAY (VCR)

CARD CAMERA

CARD PLAY (VCR)

Turn the mode dial to select a program AE mode.

The symbol of the mode appears on the upper left corner of the screen.  (Auto) disappears after 4 seconds.

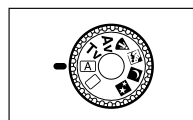

- Do not change the mode during recording as the brightness of the image may change abruptly.
- Bright light in a dark scene may cause a vertical light bar to appear. This is not a malfunction.

Using Digital Effects



You can use the digital effects during recording and playback.

E

Faders (📖 66): Begin or end scenes with a fade to or from black.

Effects (📖 69): Add flavor to your recordings.

Multi-image screen (📖 71)

Availability of Digital Effects by Operating Modes:

	CAMERA		PLAY (VCR)	CARD CAMERA	CARD PLAY (VCR)
	Movies	Still Images			
Faders	○	×	○	×	×
Effects	○	○	○	○*1	×
Multi-image screen	○*2	○*2	○	×	×

○: Available ×: Not available

*1: Black and White only.

*2: Cannot be used in Night and Super Night mode.



- Turn off the digital effect when you do not use it.
Press the SELECT button to open the menu. Select [D.EFFECTS Off] and press the SELECT button.
- The camcorder retains the setting even if you turn it off or change the program AE mode.
- The digital effect turns off if you turn the mode dial to □.
- Digital effects can be selected but not activated on a blank blue screen (appears in PLAY (VCR) mode).
- Digital effects activated during playback do not change the recording.
- Digital effects cannot be used during DV dubbing and photo/date search.
- The image quality may be slightly lower with digital effects.

Faders

Fade Trigger (FADE-T)

E

The image gradually fades in.

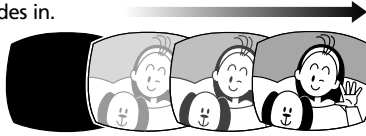

The image gradually fades out.

Wipe (WIPE)

The image begins as a vertical line in the center and expands sideways until it fills the whole screen.

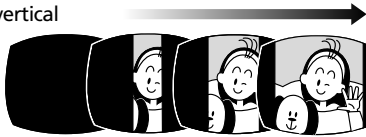

The image is wiped off from the sides of the screen.

Corner Wipe (CORNER)

The image appears from the corners until it fills the whole screen.



The image is wiped off from the corners.

Jump (JUMP)

A small image appears from the left, jumps into the center and enlarges until it fills the whole screen.

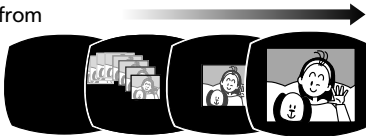

The image shrinks, jumps from the center to the left and disappears.

Flip (FLIP)

The image flips into the screen.



The image flips out of the screen.

Puzzle (PUZZLE)

The image appears in 16 pieces.
The pieces move around until the puzzle is solved.

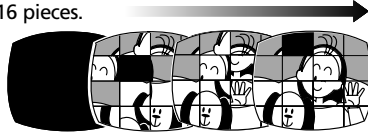

The image is divided into 16 pieces. The pieces move around and disappear.

Zigzag (ZIGZAG)

The image appears in zigzag from the top of the screen.

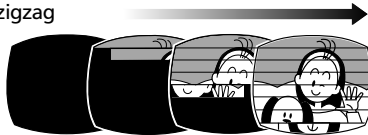

Black stripes appear in zigzag from the bottom of the screen until they cover the whole image.

Beam (BEAM)

The screen turns yellow, forms a beam that becomes thinner and the image appears.

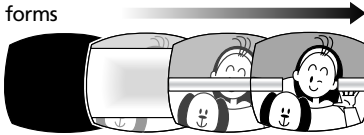

A yellow beam appears in the center of the screen and expands until it covers the whole image.

Tide (TIDE)

The image appears from both sides like tides.

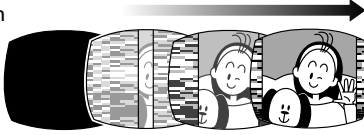

The image disappears from both sides like tides.

Selecting a Fader

E

CAMERA

PLAY (VCR)

CARD CAMERA

CARD PLAY (VCR)

1. In **CAMERA** mode, turn the mode dial to a position other than .

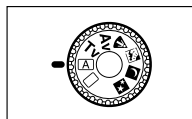

2. Press the **SELECT** button.

[D.EFFECTS , [FADER], [EFFECT] and [MULTI-S] appear.

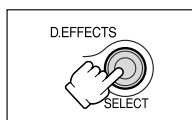

3. Select [FADER].

4. Select the fader option.

5. Press the **SELECT** button.

The name of the selected fader flashes.



CAMERA mode:

6. **Fade in:** In record pause mode, press the **ON/OFF** button and begin recording by pressing the **start/stop** button.

Fade out: During recording, press the **ON/OFF** button and pause recording by pressing the **start/stop** button.

The fader can be activated/deactivated by pressing the **ON/OFF** button.

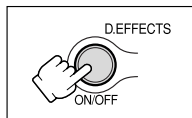

PLAY (VCR) mode:

6. **Fade in:** In playback pause mode, press the **ON/OFF** button and begin playback by pressing the **▶/||** button.

Fade out: During playback, press the **ON/OFF** button and pause playback by pressing the **▶/||** button.

The fader can be activated/deactivated by pressing the **ON/OFF** button.

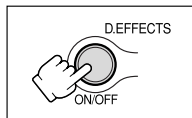

Faders cannot be selected when Card Mix is activated.

Effects

Art (ART)

The image becomes like a paint (solarization).



E

Black and White (BLK & WHT)

The image becomes black and white.



Sepia (SEPIA)

The image becomes monochrome with a brownish tint.



Mosaic (MOSAIC)

The image is blurred through enlarging the size of some pixels.

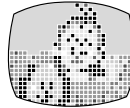

Ball (BALL)

The image becomes like a ball.



Cube (CUBE)

The image becomes a cube and rotates.



Wave (WAVE)

Both ends of the image sway in waves.



Color Masking (COLOR M.)

The image becomes a rhombus surrounded by a masking frame that changes the colors.



Mirror (MIRROR)

Creates a symmetrical image as if there would be a mirror in the center of the screen.



Using the Full Range
of Features



Only Black and White can be used in CARD CAMERA mode.

Selecting an Effect

CAMERA

PLAY (VCR)

CARD CAMERA

CARD PLAY (VCR)

1. In **CAMERA** mode, turn the mode dial to a position other than .



2. Press the **SELECT** button.

[D.EFFECTS OFF], [FADER], [EFFECT] and [MULTI-S] appear.



3. Select **[EFFECT]**.

4. Select the effect.



5. Press the **SELECT** button.

The name of the selected effect flashes.



6. Press the **ON/OFF** button.

- The name of the selected effect stops flashing.
- The effect can be activated/deactivated by pressing the ON/OFF button.

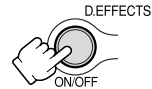

Selecting an Effect in CARD CAMERA Mode

CAMERA

PLAY (VCR)

CARD CAMERA

CARD PLAY (VCR)

1. Press the **SELECT** button.

"BLK&WHT" flashes.



2. Press the **ON/OFF** button.

- "BLK&WHT" stops flashing.
- The effect can be activated/deactivated by pressing the ON/OFF button.

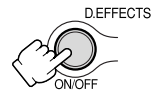

Using the Multi-Image Screen



The multi-image screen captures moving subjects in 4, 9 or 16 sequences of still images with the Image Capture feature and displays them at one time. Sound will be recorded normally. This feature can be used in CAMERA and PLAY (VCR) mode.

You can choose the transition speed at which to capture the subject from manual, fast (every 4 frames), moderate (every 6 frames) or slow (every 8 frames).

E

Selecting the Multi-Image Screen

CAMERA

PLAY (VCR)

CARD CAMERA

CARD PLAY (VCR)

1. In **CAMERA** mode, turn the mode dial to a position other than ,  and .

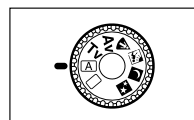

2. Press the **SELECT** button.

[D.EFFECTS , [FADER], [EFFECT] and [MULTI-S] appear.

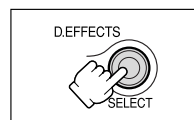

3. Select **[MULTI-S]**.

[S.SPEED] and [S.SPLIT] appears.

4. Select **[S.SPEED]**.

[MANUAL], [FAST], [MOD.] and [SLOW] appear.

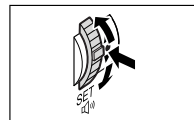

5. Select the transition speed.

6. Select **[MULTI-S]** again.

[S.SPEED] and [S.SPLIT] appears.

7. Select **[S.SPLIT]**.

[4], [9], [16] settings appear.

8. Select the number of sequences.

9. Press the **SELECT** button.

[MULTI-S] flashes.

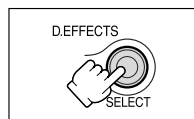

Using the Full Range
of Features

Capturing

10. Press the ON/OFF button.

E

- **MANUAL:** Images will be captured each time you press the ON/OFF button. The blue frame indicating the next sequence disappears after the last image. To cancel the last captured image, press and hold the ON/OFF button. To cancel the multi-image screen, press and release the ON/OFF button.
- **FAST, MODERATE, SLOW:** The set number of images will be captured at the set speed. To cancel the multi-image screen, press the ON/OFF button.

11. Press the start/stop button to begin recording.

The multi-image screen is recorded on the tape.



- The multi-image screen can be operated in record or record pause mode.
- You can operate the multi-image screen only in the following playback modes:
 - When [S.SPEED] is set to [MANUAL]: Playback pause, slow forward/reverse playback
 - When [S.SPEED] is set to [FAST], [MOD.] or [SLOW]: Playback pause
- The multi-image screen cannot be selected in Easy Recording, Night and Super Night mode.
- The multi-image screen cannot be selected when 16:9 or Card Mix is activated.
- In PLAY (VCR) mode: Pressing any tape operation button (such as play or pause), or performing date/photo search cancels the multi-image screen.

Turning Off the Image Stabilizer



E

Canon's optical image stabilizer allows you to obtain steady recordings even at telephoto. Unlike electronic image stabilizers, it causes no loss in picture quality. There is no need to turn off the image stabilizer during normal recording. However, the camcorder tries to compensate for horizontal movements and you may therefore decide to turn it off during panning. The image stabilizer cannot be turned off in the Easy Recording mode.



Open the menu and select [CAMERA SET UP]. Select [IMAGE S. (IS)], set it to [OFF] and close the menu.

(IS) disappears.



- This function can be assigned to the CSTM KEY (43).
- We recommend turning off the image stabilizer when you mount the camcorder on a tripod.
- The image stabilizer is designed to compensate a normal degree of camcorder shake.

Recording With the Self-Timer



E

CAMERA

PLAY (VCR)

CARD CAMERA

CARD PLAY (VCR)

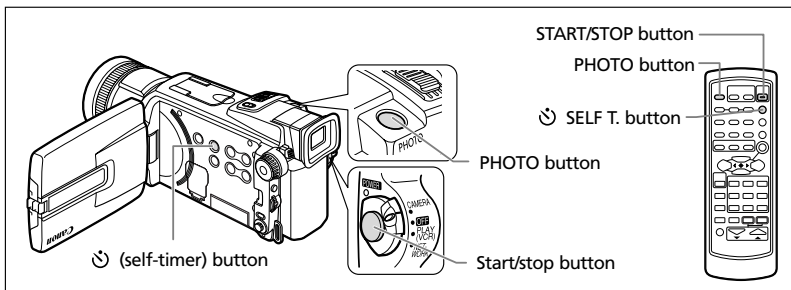

1. Press the (self-timer) button.

 “ ” appears.



When recording movies

2. Press the start/stop button.

- The camcorder starts recording after a 10-second countdown (2 seconds when using the wireless controller). The count down appears on the screen.
- The tally lamp starts flashing.

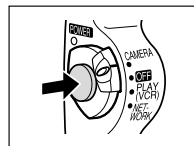

3. Press the start/stop button to stop recording.

The camcorder returns to record pause mode.

When recording still images

2. Press the PHOTO button.

- The camcorder starts recording after a 10-second countdown (2 seconds when using the wireless controller). The count down appears on the screen.
- The tally lamp starts flashing.
-  appears in green 2 seconds before recording begins.
- The camcorder records the still image for approx. 6 seconds and returns to record pause mode (in CARD CAMERA mode, it displays the still image when recording is complete).

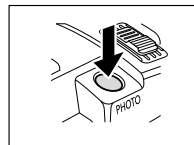

- To cancel the self-timer, press the  (self-timer) button. Once the countdown has begun, you can also press the start/stop button (when recording movies) or the PHOTO button (when recording still image) to cancel the self-timer.

- The self-timer will be canceled when you turn off the camcorder.

Audio Recording

Changing the Audio Mode



E

You can record sound in two audio modes—16-bit and 12-bit. The 12-bit mode records sound on two channels (stereo 1), leaving 2 channels free (stereo 2) for adding new sound later. Select the 16-bit mode for higher sound quality.



Open the menu and select [AUDIO SET UP]. Select [AUDIO MODE], set it to [16bit] and close the menu.

“16bit” appears for approximately 4 seconds.



For adding new sound, see *Audio Dubbing* (105).

Adjusting the Audio Recording Level



You can manually adjust the audio recording level of the built-in microphone or an external microphone connected to the MIC terminal or advanced accessory shoe.

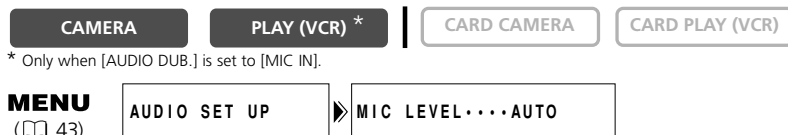

* Only when [AUDIO DUB.] is set to [MIC IN].

1. Turn the mode dial to a position other than .
2. Open the menu and select [AUDIO SET UP]. Select [MIC LEVEL], set it to [MANUAL] and close the menu.

Check if a green bar is displayed below the indicator. If not, press the AUDIO LEVEL button to display the bar.

3. Adjust the level with the selector dial.

- The maximum level should only slightly exceed -12 dB.
- Sound may be distorted if the indicator for 0 dB lights up in red.

4. Press the AUDIO LEVEL button to hide the green bar.

The audio level can only be changed when the green bar is displayed. We recommend hiding the bar to prevent accidental changes.



- The microphone level resets to [AUTO] when you turn the mode dial to □.
- We recommend using headphones when manually adjusting the audio level.
- When recording near loud sounds (such as fireworks, drums or concerts), sound may become distorted or may be recorded not in the actual sound level.
- If sound is distorted, turn on the microphone attenuator.

E

Audio Level Indicator

- In auto mode, you can display or hide the audio level indicator by pressing the AUDIO LEVEL button.
- When [MIC LEVEL] is set to [MANUAL], the symbol “M” and a green bar is shown.
- The green bar shows the level of the microphone (it increases to the right and decreases to the left).



Microphone Attenuator



Use the microphone attenuator if you need to lower the volume level or correct audio distortion during recording or audio dubbing. Check the audio levels with headphones.



Open the menu and select [AUDIO SET UP]. Select [MIC ATT], set it to [ON] and close the menu.

Recording with an External Microphone

You can use an external microphone for recording. Almost all stereo microphones with a plug diameter of 0.14 inch (3.5 mm) can be connected to the MIC terminal. Use a microphone with a built-in power supply (condenser microphone).

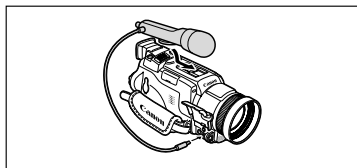

- The audio level differs from that of the built-in microphone.
- Be careful with long microphones as they may appear in the picture.
- See also *Using the DM-50 Microphone* (□ 81).

Wind Screen



You can reduce the wind noise when recording in windy places.



E

MENU
(43)

AUDIO SET UP

▶ WIND SCREEN · · OFF

Open the menu and select [AUDIO SET UP]. Select [WIND SCREEN], set it to [ON] and close the menu.

“WS ” appears when you turn the wind screen on.



- Low sound may be reduced together with the wind noise. We recommend turning off the wind screen for normal recordings.
- The wind screen function cannot be turned on/off during recording.
- The wind screen function can also be used for audio dubbing (when [AUDIO DUB.] is set to [MIC. IN] in the [AUDIO SET UP] submenu).
- The wind screen function cannot be used when an external microphone is connected to the MIC terminal or when the DM-50 Microphone is attached to the advanced accessory shoe.

Using Headphones during Recording



You can use headphones to monitor the sound during recording and adjust the volume.



MENU
(43)

AUDIO SET UP

▶ VOLUME · · · · ·

Open the menu and select [AUDIO SET UP]. Select [VOLUME], adjust the volume with the selector dial and close the menu.

You can turn off the volume completely by turning the selector dial down until [OFF] appears. Turn the selector dial up to increase the volume again.

Using the VL-3 Video Light (Optional)

E

This VL-3 Video Light attaches to the camcorder's advanced accessory shoe for cable-free operation and is powered by the camcorder's power supply. Refer also to the VL-3 Video Light instruction manual.



- Always turn off the camcorder before attaching/removing the video light.
- Do not touch or place flammable material or plastic close to the lamp or the surrounding parts during or immediately after use; they become very hot.
- Do not look directly at the lamp while the video light is on.
- Do not carry the camcorder by the video light.

1. Remove the accessory shoe cover.

2. Slide the video light into the accessory shoe until it clicks.

3. Tighten the shoe lock.

Make sure that the video light is securely attached to the camcorder.

4. Set the camcorder to CAMERA or CARD CAMERA mode.

5. Set the video light's power switch to AUTO or ON.

- "C" (Connection) appears.
- ON: The video light stays on.
- AUTO: The video light turns on and off automatically.

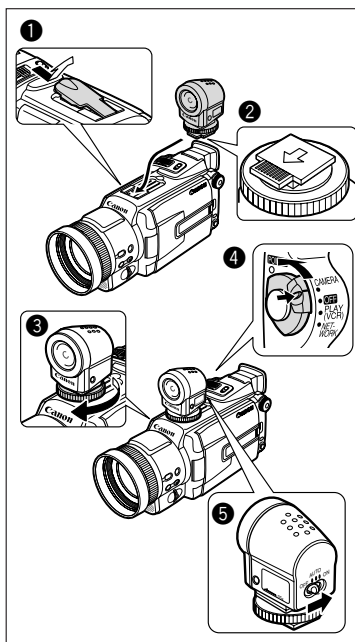

- The built-in flash does not fire when you attach the video light and set its POWER switch to a position other than OFF.
- Keep the distance to the subject within 1 to 2 m when recording with the video light.
- When recording in wide-angle, the corners of the screen may appear darker.
- The recording time of a battery pack shortens when using the video light. We recommend having extra battery packs on hand.
- When the battery pack is exhausted, the brightness of the video light changes. This is not a malfunction.
- If you point the camcorder at a mirror or other reflective subjects when the video light is set to AUTO, it may turn on and off repeatedly.

Using the VFL-1 Video Flash Light (Optional)

This video flash light attaches to the camcorder's „S” advanced accessory shoe for cable-free operation and is powered by the camcorder's power supply.

Using it as video light, you can set it to turn on and off automatically according to the surrounding brightness. The flash has a higher intensity than the built-in flash and can be set to the same modes as the built-in flash.

Refer also to the VFL-1 Video Flash Light instruction manual.



- Always turn off the camcorder before attaching/removing the video flash light.
- Do not carry the camcorder by the video flash light.



The built-in flash does not fire when you attach the video flash light and set its POWER switch to a position other than OFF.

Attaching the Video Flash Light

1. Remove the accessory shoe cover.
2. Slide the video flash light into the accessory shoe until it clicks.
3. Tighten the shoe lock.

Makes sure that the video flash light is securely attached to the camcorder.

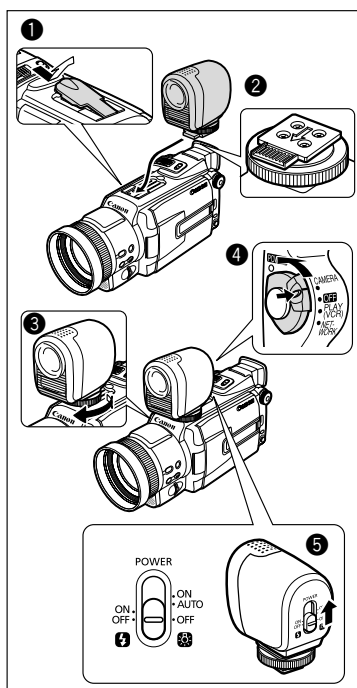

Using the Video Flash Light as Flash

If you attach the video flash light and set it to  ON, the video flash light fires in place of the built-in flash. Refer to *Using the Built-in Flash* (📖 59) for instructions on selecting the flash mode.

CAMERA

PLAY (VCR)

CARD CAMERA

CARD PLAY (VCR)

1. Set the camcorder to **CAMERA** or **CARD CAMERA** mode.

2. Set the video flash light's **POWER** switch to  ON.

“” (Connection) appears.



- Do not fire the flash close to people's eyes.
- Do not fire the flash at persons while they are driving.
- Do not fire the flash with the flash bulb covered with your hand.



- The practical range of the flash is approx. 3.3 to 13.1 ft. (1 to 4 m). The range depends upon the recording condition.
- The camcorder fires a pre-flash to obtain the subject's exposure data and adjusts the main flash to the optimal intensity (flash exposure compensation). When  (red-eye reduction, auto) is set, the pre-flash fires between the flash for red-eye reduction and the main firing (the main firing takes place about 1 second after the flash for red-eye reduction).

Using the Video Flash Light as Video Light

CAMERA

PLAY (VCR)

CARD CAMERA

CARD PLAY (VCR)

1. Set the camcorder to **CAMERA** or **CARD CAMERA** mode.

2. Set the video flash light's **POWER** switch to  AUTO or  ON.

- “” (Connection) appears.
- ON: The video light stays on.
- AUTO: The video light turns on and off automatically.



- Do not touch or place flammable material or plastic close to the lamp or the surrounding parts during or immediately after use; they become very hot.
- Do not look directly at the lamp while the video light is on.



- Keep the distance to the subject within 3.3 to 6.6 ft. (1 to 2 m) when recording with the video light.
 - When recording in wide-angle, the corners of the screen may appear darker.
 - The recording time of a battery pack shortens when using the video light. We recommend having extra battery packs on hand.
 - When the battery pack is exhausted, the brightness of the video light changes. This is not a malfunction.
 - If you point the camcorder at a mirror or other reflective subjects when the video light is set to AUTO, it may turn on and off repeatedly.

Using the DM-50 Microphone (Optional)

The high sensitive Directional Stereo Microphone DM-50 attaches to the “S” advanced accessory shoe for cable-free operation and is powered by the camcorder’s power supply. Use it for recording or dubbing audio.

Refer also to the DM-50 Microphone instruction manual.



- Always turn the camcorder off before attaching/removing the microphone.
- Do not connect any microphone to the MIC terminal when the DM-50 Microphone is connected.
- Do not carry the camcorder by the microphone.

1. Remove the accessory shoe cover.

2. Slide the microphone into the accessory shoe until it clicks.

3. Tighten the shoe lock.

Make sure that the microphone is securely attached to the camcorder.

4. Set the camcorder to CAMERA or CARD CAMERA mode.

“” (Connection) appears.

5. Set the microphone’s directivity switch.

- SHOTGUN: For recording clear sound from the front (monaural).
- STEREO 1: For recording sound from the front and surrounding area.
- STEREO 2: For recording surrounding sound in a wider range than in STEREO 1.

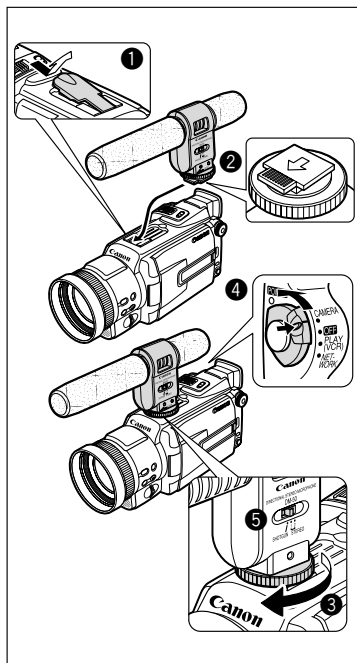

E

Using the Full Range
of Features

Adjusting the Focus Manually



E



Autofocus may not work well on the following subjects:

Reflective surfaces



Subjects with low contrast (e.g. White Wall)



Fast Moving Subjects



Through dirty or wet windows



CAMERA

PLAY (VCR)

CARD CAMERA

CARD PLAY (VCR)

1. Turn the mode dial to a position other than .

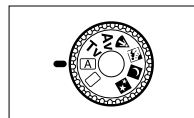

2. Adjust the zoom.

When you operate the zoom after adjusting the focus, the subject may not stay in focus. Adjust the zoom before the focus.

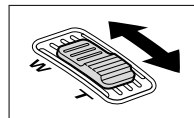

3. Press the FOCUS A/M button.

"MF" appears.

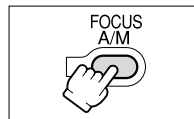

4. Turn the focus ring to adjust the focus.

Turn the focus ring up or down until the image appears focused.

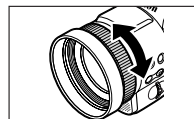

5. Press the FOCUS A/M button to return to autofocus.

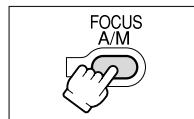

The setting resets to autofocus when you turn the mode dial to .

Infinity Focus

Use this function when you wish to focus on faraway subjects such as mountains or fireworks.

E

Press the FOCUS A/M button more than 3 seconds in step 3.

“MF ∞” appears. When you operate the zoom or turn the focus ring, “∞” disappears and the camcorder changes to manual focus.

Adjusting Exposure Manually



E

Exposure Lock

You can lock the exposure when recording in situations where the lighting may change suddenly to control the brightness of the image.

CAMERA

PLAY (VCR)

CARD CAMERA

CARD PLAY (VCR)

1. Turn the mode dial to a position other than .

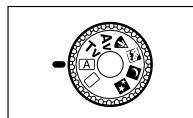

2. Press the EXP dial.

- "E.LOCK ±0" appears on the screen.
- When you operate the zoom, the brightness of the image may change.

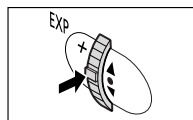

Exposure Adjustment

When the exposure is locked, you can adjust it manually to handle difficult lighting conditions. The camcorder's iris can be set to any position from fully closed to fully open.

CAMERA

PLAY (VCR)

CARD CAMERA

CARD PLAY (VCR)

Turn the EXP dial to adjust the brightness of the image.

- To make the image brighter, turn the EXP dial up (to a maximum of +11).
- To make the image darker, turn the EXP dial down (to a minimum of -11).

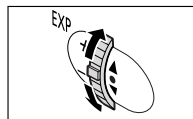

○ Press the EXP dial to return to auto exposure.

○ The adjustment range depends on the brightness at the time you locked the exposure.

Using the Zebra Pattern



The zebra pattern is a series of diagonal stripes that appear on the screen to indicate overexposed areas. Use it as a guide when setting the exposure, aperture or shutter speed.

E



Open the menu and select [CAMERA SET UP]. Select [ZEBRA], set it to [ON] and close the menu.



- The zebra pattern will not be recorded.
- The zebra pattern cannot be selected when the mode dial is set to .
- This function can be assigned to the CSTM KEY (📖 53).

Backlight Compensation



When the subject is backlit, it may appear underexposed. You can correct this with the backlight compensation function.



Open the menu and select [CAMERA SET UP]. Select [BLC], set it to [ON] and close the menu.



- Backlight compensation cannot be selected when the mode dial is set to .
- This function can be assigned to the CSTM KEY (📖 53).

Setting the Shutter Speed (Tv Mode)



E

In **Tv** (Shutter-Priority) mode, you can adjust the shutter speed to make stable shots of fast moving subjects or when recording in dimly lit places.

CAMERA

PLAY (VCR)

CARD CAMERA

CARD PLAY (VCR)

1. Turn the mode dial to **Tv**.

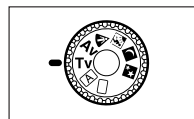

2. Turn the EXP dial to select the shutter speed.

Turn the EXP dial up for a slower shutter and down for a faster shutter.

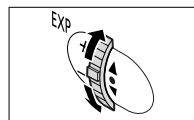

CAMERA Mode	CARD CAMERA Mode
1/8	1/2
1/15	1/4
1/30	1/8
1/60	1/15
1/100	1/30
1/250	1/60
1/500	1/100
1/1000	1/250
1/2000	1/500

Using the Full Range
of Features



- Aperture is adjusted automatically.
- If the shutter speed is set to 1/1000 or higher in CAMERA mode and you switch to CARD CAMERA mode, it automatically changes to 1/500.
- If the shutter speed is set to 1/4 or slower in CARD CAMERA mode and you switch to CAMERA mode, it automatically changes to 1/8.
- If you set a shutter speed that is either too high or too low for the recording condition, the indicator flashes. Increase or decrease the setting until the flashing stops.
- Recording under fluorescent lights in CAMERA mode: When the camcorder is set to Easy Recording, Auto, Night or Super Night mode, it automatically detects the flicker of fluorescent lighting and adjusts the shutter speed accordingly. However, if the brightness of the screen starts to flicker, select Tv mode and set the shutter speed to 1/100.
- When recording in dark places, we recommend using the Video Flash Light VFL-1 or Video Light VL-3 (both optional).

○ Guidelines for Recording with High Shutter Speeds:

- Outdoor sports such as golf or tennis: 1/2000
- Moving objects such as cars or roller coasters: 1/1000, 1/500 or 1/250
- Indoor sports such as basketball: 1/100



E

- Do not point the camcorder directly at the sun when the shutter speed is set to 1/1000 or higher.
- The image may flicker when recording with high shutter speeds.

○ Guidelines for Recording with Slow Shutter Speeds (CAMERA mode: 1/8, 1/15, 1/30; CARD CAMERA mode: 1/2, 1/4, 1/8, 1/15, 1/30):

- Use a slow shutter in dimly lit places, when panning on a moving subject or to create a trailing effect.
- The image quality may be slightly lower when recording with slow shutter speeds.
- Autofocus may not work with slow shutter speeds. In such case, adjust the focus manually.

Setting the Aperture (Av Mode)



E

Select the aperture to control the depth of field to give accent to your subject by blurring the background or the foreground.

CAMERA

PLAY (VCR)

CARD CAMERA

CARD PLAY (VCR)

1. Turn the mode dial to Av .

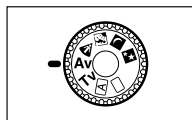

2. Turn the EXP dial to select the aperture.

- Turn the EXP dial up to open the aperture (decrease the F number) and down to close the aperture (increase the F number).
- Available settings: F1.6 (1.8 in CARD CAMERA mode), F2.0, F2.4, F2.8, F3.4, F4.0, F4.8, F5.6, F6.7, F8.0

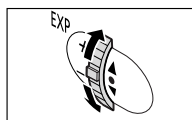

Using the Full Range
of Features

- Shutter speed is adjusted automatically.
- If you set an aperture that is either too high or too low for the recording condition, the indicator flashes. Increase or decrease the setting until the flashing stops.

Setting the White Balance



The camcorder's auto white balance system adjusts the colors to appear natural for different lighting conditions. However, you can use the preset modes to reproduce colors more accurately, or set a custom white balance to obtain the optimal setting.

E

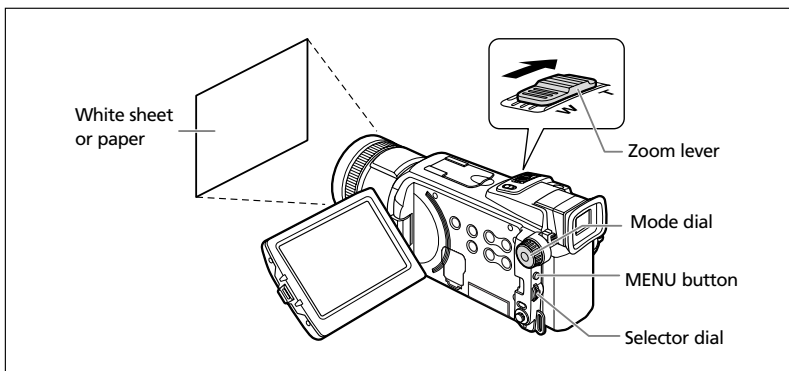

- In the Easy Recording mode, white balance is preset to [AUTO]. Indoor, outdoor and custom white balance cannot be selected.
- The camcorder retains the custom white balance setting even if you turn it off. However, it resets to [AUTO] when you change the position of the TAPE/CARD switch.
- When you have set the custom white balance:
 - Reset the white balance when the lighting condition changes.
 - Turn off the digital zoom.
- Setting the white balance manually may provide better results in the following cases:
 - Changing lighting conditions
 - Close-ups
 - Subjects in a single color (sky, sea or forest)
 - Under mercury lamps or certain types of fluorescent lights
- Use the ☼ Indoor or ☀ Outdoor mode in the following cases:
 - ☼ Indoor:
 - Changing lighting condition
 - Under video light
 - Under sodium lamps
 - ☀ Outdoor:
 - For night scenes or fireworks
 - Sunrise or sunset
- * Use the auto setting for normal outdoor scenes.

CAMERA

PLAY (VCR)

CARD CAMERA

CARD PLAY (VCR)

E





MENU

( 43)





CAMERA SET UP

▶ WHITE BAL. . . . AUTO

For  (Indoor) or  (Outdoor) Setting:

1. Turn the mode dial to a position other than .
2. Open the menu and select [CAMERA SET UP].
3. Select [WHITE BAL.].
4. Select [INDOOR ] or [OUTDOOR ].
"  " or "  " appears.
5. Close the menu.

For Custom White Balance:

1. Turn the mode dial to a position other than .
2. Open the menu and select [CAMERA SET UP].
3. Select [WHITE BAL.].
4. Point the camcorder at a white object (such as a sheet of paper), zoom in until it fills the whole screen and select [SET ].
 -  flashes and stops flashing when settings is complete.
 - Depending on the light source,  may keep flashing. The result will still be better than with the auto setting.
5. Close the menu.

Magnifying the Image



The playback image can be magnified up to 5 times.

CAMERA

PLAY (VCR)

CARD CAMERA

CARD PLAY (VCR)

E

1. Move the zoom lever toward **T**.

- The image is magnified by 2 times.
- A frame appears indicating the position of the magnified area.
- To further enlarge the image, move the zoom lever toward **T**.
To shrink the image below 2 times magnification, move the zoom lever toward **W**.

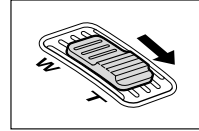

2. Select the magnified area with the P.SET controller.

To cancel the magnification, move the zoom lever toward **W** until the frame disappears.

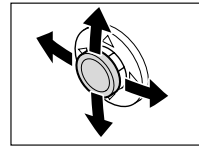

Movies played back from a memory card cannot be magnified.

Displaying the Data Code



E

Once date and time are set, the camcorder maintains a data code containing recording date and time and other camera data such as shutter speed and exposure (f-stop). Only date and time appear when playing back a memory card.

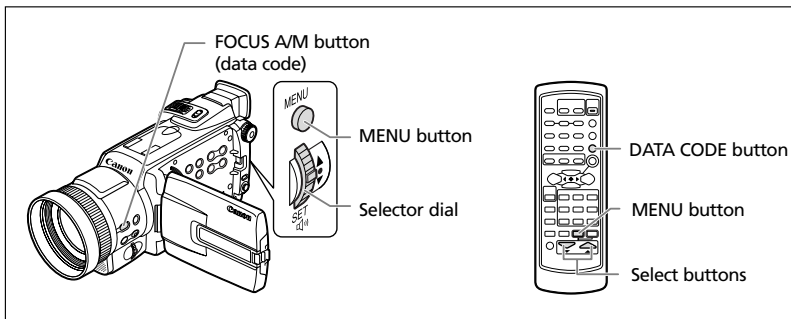

- The data code display turns off when you turn the camcorder off.
- The data code may not be displayed if a recording made with this camcorder is played back on a different digital camcorder.
- Camera data may not appear in some special playback modes.
- When the TV screen displays are hidden (153), the displays still appear on the LCD screen. If you turn on the data code, displays other than the data code will disappear from the LCD screen.

Using the Full Range of Features

Available Data Code Combinations (in PLAY (VCR) mode):

DATA CODE (tape only) D/TIME SEL.	Date/Time	Camera data	Date/Time & Camera data
Date	JAN. 1, 2003	F1.6 1/250	F1.6 1/250 JAN. 1, 2003
Time	12:00:00 PM	F1.6 1/250	F1.6 1/250 12:00:00 PM
Date & Time	12:00 PM JAN. 1, 2003	F1.6 1/250	F1.6 1/250 12:00 PM JAN. 1, 2003

Selecting the Date/Time Display Combination



Open the menu and select [DISPLAY SET UP]. Select [D/TIME SEL.], set it to [DATE] or [TIME] and close the menu.

Selecting the Data Code Display Combination



Open the menu and select [DISPLAY SET UP]. Select [DATA CODE], set it to [CAMERA DATA] or [CAM. & D/T] and close the menu.

Displaying the Data Code



Press the FOCUS A/M button.

Only date and time appear in CARD PLAY (VCR) mode.

Six-Second Auto Date

Date and time appear for 6 seconds when you begin playback, or to indicate that date or time zone has changed.



Open the menu and select [DISPLAY SET UP]. Select [6SEC.DATE], set it to [ON] and close the menu.

Photo Search/Date Search



E

You can search for a still image recorded anywhere on the tape with the photo search function, or locate the change of the date/time zone with the date search function.

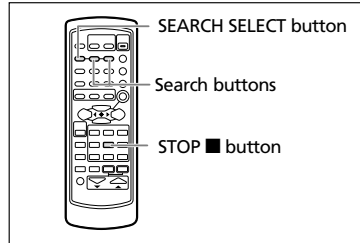

CAMERA

PLAY (VCR)

CARD CAMERA

CARD PLAY (VCR)

1. Press the SEARCH SELECT button to choose between photo search and date search.

“PHOTO SEARCH” or “DATE SEARCH” appears.

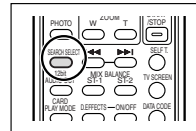

2. Press the ►► or ◀◀ button to begin searching.

- Press the ►► button to search forward and the ◀◀ button to search backward.
- Press more than once to search for further still images or date changes (up to 10 times).
- Press the ►► or ◀◀ button to change the search direction.
- Press the ■ (stop) button stop searching.

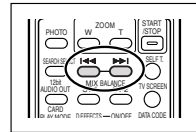

Using the Full Range of Features



- Photo search: A still image recorded very close to the point you start the search may not be detected.
- Date search: A recording of longer than a minute per date/area is required.
- Date search: Playback may start slightly before or after the date change.
- Date search may not function if the data code is not correctly displayed.

Returning to a Pre-marked Position



If you wish to return to a particular scene later, mark the point with the zero set memory and the tape will stop at that point when you rewind/fast forward the tape.

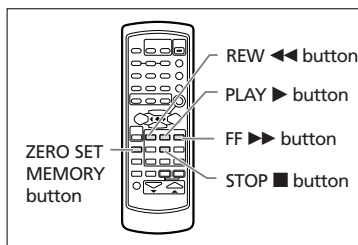

E

CAMERA

PLAY (VCR)

CARD CAMERA

CARD PLAY (VCR)

1. Press the ZERO SET MEMORY button at the point you wish to return to later.

- "0:00:00 M" appears.
- To cancel, press the ZERO SET MEMORY button again.

2. When you have finished playback, fast forward or rewind the tape.

- "RTN >>>" or "<<< RTN" appears.
- The tape stops automatically at "0:00:00".
- The tape counter changes to time code.

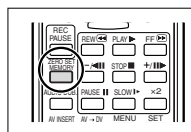

- Time code and tape counter display may not match accurately.
- The zero set memory may not function correctly when blank sections exist on the tape.
- If you remove the tape, the zero set memory is canceled and the counter display shows the time code.

Using the Full Range
of Features

Recording to a VCR or Digital Video Device

E

You can copy your recordings by connecting the camcorder to a VCR or a digital video device. If you connect a digital video device, you can copy recordings with virtually no generation loss in image and sound quality.



When connecting a VCR:

- The quality of the edited tape will be slightly lower than that of the original.

When connecting a digital video device:

- You can connect only one device to the camcorder with the DV cable.
- Blank sections may be recorded as anomalous picture.
- If the picture does not appear, reconnect the DV cable or turn the camcorder off and back on again.
- Proper operation cannot be guaranteed for all digital video devices equipped with a DV terminal. If operation does not work, use the S-video or AV terminal.

Example: Recording to a VCR

CAMERA

PLAY (VCR)

CARD CAMERA

CARD CAMERA

1. Connect the camcorder to the VCR.

See *Playing Back on a TV Screen* (□ 40).

2. Set the camcorder to **PLAY (VCR)** mode and load a recorded cassette.

3. Connected device: Load a blank cassette and set the device to record pause mode.

4. Locate the scene you wish to copy and pause playback shortly before the scene.

5. Play back the tape.

6. Connected device: Begin recording when the scene you wish to copy appears. Stop recording when copying is complete.

7. Stop playback.

Editing

Connecting a Digital Video Device

Refer also to the instruction manual of the digital video device.

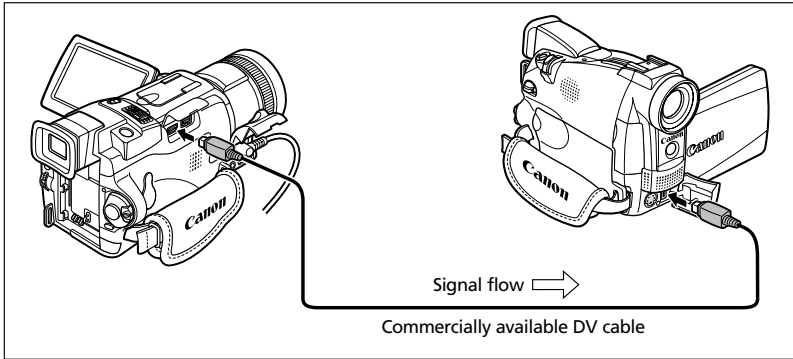

E

Editing

Recording from Analog Video Devices (VCR, TV or Camcorder)



E

You can record videos or TV programs from a VCR or analog camcorder on the tape in the camcorder.



- Anomalous signals sent from the connected device may be recorded as anomalous picture (although it may not appear so on the screen), or it may not be recorded at all.
- You cannot record from tapes with copyright protective signals.

CAMERA

PLAY (VCR)

CARD CAMERA

CARD CAMERA

1. Connect the camcorder to the analog video device.

See *Playing Back on a TV Screen* (📖 40).

2. Set the camcorder to **PLAY (VCR)** mode and load a blank cassette.

3. Connected device: Load the recorded cassette.

4. Press the **REC PAUSE** button.

In record pause mode and during recording, you can check the picture on the screen.



5. Connected device: Play back the tape.

6. Press the **▶/||** button when the scene you wish to record appears.

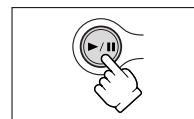

7. Press the **■** button to stop recording.

- Press the **▶/||** button to pause recording.
- Press the **▶/||** button again to restart recording.

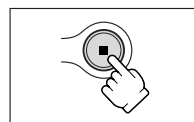

8. Connected device: Stop playback.

Editing

Recording from Digital Video Devices (DV Dubbing)



E

You can record from other digital video devices equipped with a DV terminal with virtually no loss in picture and sound quality.



- When recording from digital video devices, make sure that “AV → DV” is not displayed on the screen. If “AV → DV” is displayed, change the setting (📖 102).
- Anomalous signals sent from the connected device may be recorded as anomalous picture (although it may not appear so on the screen), or it may not be recorded at all.
- Copyright protected signals cannot be recorded.
- Blank sections may be recorded as anomalous picture.
- If the picture does not appear, reconnect the DV cable or turn the camcorder off and back on again.
- You can only record signals from devices with the **DV** logo recording in SD system in SP or LP format.



- You can connect only one device with the DV cable.
- You can use the camcorder for playback and recording without reconnecting the DV cable.

CAMERA

PLAY (VCR)

CARD CAMERA

CARD CAMERA

1. Connect the camcorder to the digital video device.

See *Connecting a Digital Video Device* (📖 97).

2. Set the camcorder to PLAY (VCR) mode and load a blank cassette.

“DV IN” appears.

3. Connected device: Load the recorded cassette.

4. Press the REC PAUSE button.

In record pause mode and during recording, you can check the picture on the screen.

5. Connected Device: Play back the tape.

6. Press the ►/|| button when the scene you wish to record appears.

7. Press the ■ button to stop recording.

- Press the ►/|| button to pause recording.
- Press the ►/|| button again to restart recording.

8. Connected Device: Stop playback.

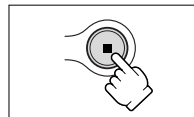
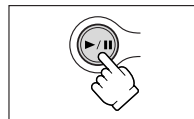
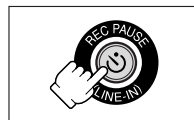

Editing

Copyright Signal

E

Certain software tapes are copyright protected. If you attempt to play back such tape, "COPYRIGHT PROTECTED PLAYBACK IS RESTRICTED" appears and you will not be able to view the contents of the tape. If you attempt to record from such tape via the DV terminal, "COPYRIGHT PROTECTED DUBBING RESTRICTED" appears and you will not be able to record the contents of the tape.

Editing

Converting Analog Signals into Digital Signals (Analog-Digital Converter)

E

By connecting the camcorder to a VCR or 8mm video camcorder, you can convert analog video/audio signals to digital signals and output the digital signals via the DV terminal. The DV terminal serves as output terminal only.



- Unload the tape from the camcorder.
- Turn off all devices before starting the connections.
- Depending on the signal sent from the connected device, the conversion from analog to digital signals might not work properly (e.g., signals that include copyright protective signals or anomalous signals such as ghost signals).



We recommend powering the camcorder from a household power source.

Connecting the Devices

This illustration shows how to connect using a S-video cable. You can also connect the yellow plug of the stereo video cable to the VIDEO terminal. Refer also to the instruction manual of the connected device.

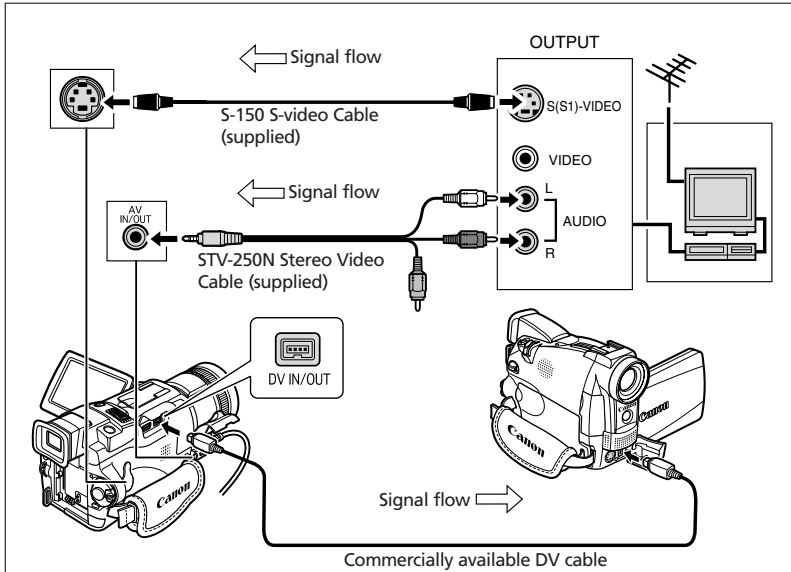

Editing

Turning On the Analog-Digital Converter

CAMERA

PLAY (VCR)

CARD CAMERA

CARD CAMERA

E

Press the **AV → DV** button on the wireless controller.

OR

MENU

( 43)

VCR SET UP



AV → DV OUT OFF

Open the menu and select [VCR SET UP]. Select [AV → DV OUT], set it to [ON] and close the menu.



- For normal use, set [AV → DV OUT] to [OFF] (so that “AV → DV” does not appear on the screen). If it is set to [ON], digital signals cannot be input via the camcorder's DV terminal.
- Depending on the software and the specifications of your computer, you may not be able to transfer converted signals via the DV terminal.

Replacing Existing Scenes (AV Insert)



You can insert and replace images/audio on the tape of the camcorder with images/audio from other video devices connected via AV terminal or DV terminal.

E

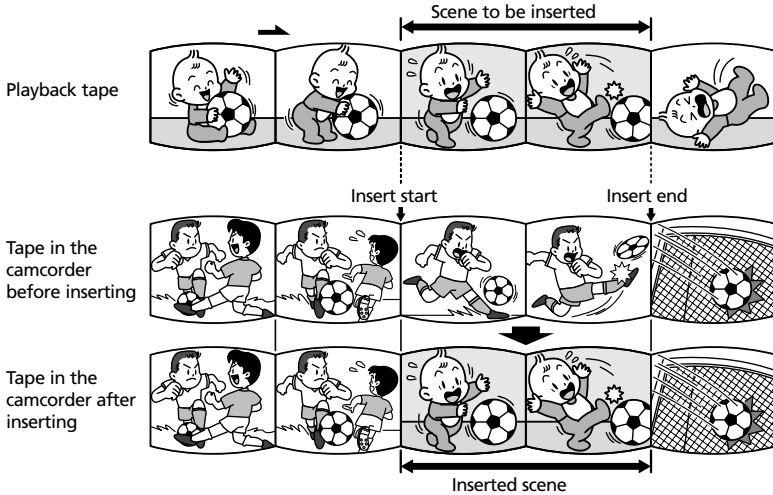

○ You cannot insert from a TV program when the synchronized signals are distorted.

Camcorder:

○ Use only tapes recorded in SP mode.

○ AV insert will stop if the camcorder detects a blank section or a section not recorded in SP mode on the tape.

Connected device:

○ Use only tapes without blank sections.

○ AV insert may not work correctly if the tape has a blank section or changes in the recording mode.

○ AV insert cannot be performed when the quality of the recording is poor, or during special playback such as fast forward, rewind, playback pause, slow playback etc.

Example: AV Insert from a VCR

CAMERA

PLAY (VCR)

CARD CAMERA

CARD CAMERA

E

1. Connect the camcorder to the VCR.

See *Playing Back on a TV Screen* (□ 40).

2. VCR: Load a recorded cassette. Locate the scene you wish to insert and pause playback shortly before the scene.

3. Set the camcorder to PLAY (VCR) mode and load a recorded cassette.

Make sure the tape-protect switch is set to allow recording.

4. Locate the scene you wish to replace and pause playback shortly before the scene.

You can use the playback buttons on the camcorder or the special playback buttons on the wireless controller.

5. Press the AV INSERT button on the wireless controller.

“AV INSERT” and “●||” appear.

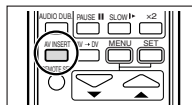

6. VCR: Play back the tape.

7. Press the PAUSE button on the wireless controller when the scene you wish to insert appears.

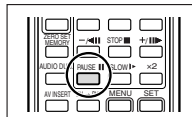

8. Press the STOP button on the wireless controller to stop inserting.

Press the PAUSE button on the wireless controller to pause inserting.

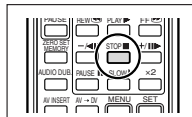

9. VCR: Stop playback.



Set the zero set memory at the end of the scene you wish to replace. The camcorder will automatically stop AV insert at that point.

Audio Dubbing



You can add sound from audio devices (AUDIO IN) or with the built-in or an external microphone (MIC. IN).

E



- Use only tapes recorded in SP mode 12-bit audio sound with this camcorder. Audio dubbing will stop if the tape has a blank section or a section recorded in LP mode, 16-bit or 12-bit 4-channel sound. In above case, create a copy in SP mode 12-bit audio sound using the analog line-in function.
- Do not connect/disconnect any cable to/from the camcorder while dubbing.
- You cannot use the DV terminal for audio dubbing.
- If you add sound to a tape not recorded with this camcorder, sound quality may decrease.
- Sound quality may decrease when you add sound to the same scene for more than 3 times.

Connecting an Audio Device

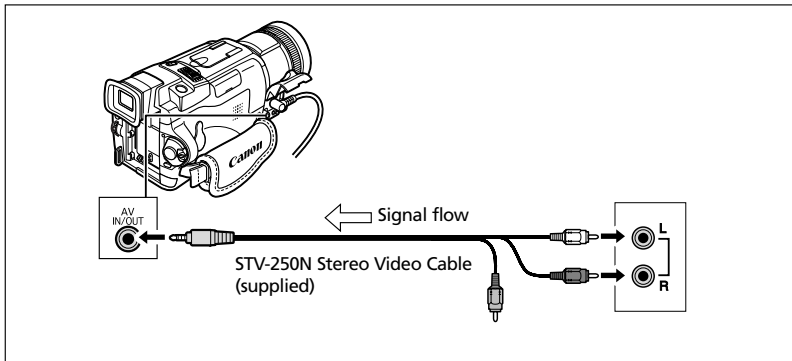

Editing



You can monitor the picture on the LCD screen or a TV connected via the S-video terminal, and check the sound with the built-in speaker or headphones.

Using a Microphone

E

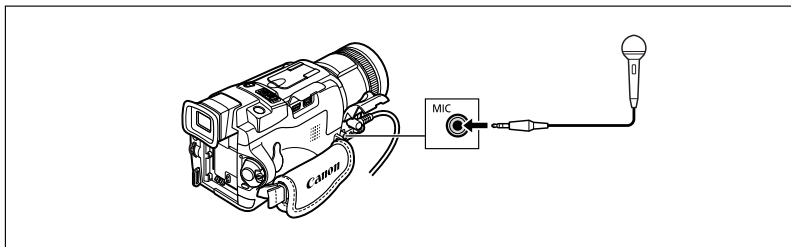

- When using the built-in microphone: Do not connect any cables to the microphone terminal or the accessory shoe.
- When using an external microphone: Connect it to the microphone terminal.
- When using the DM-50 Microphone: Do not connect any cables to the microphone terminal.
- When you connect a TV via the S-video terminal or AV terminal, you can check the picture on the TV screen and the sound with headphones connected to the camcorder.

Dubbing



Editing

1. Set the camcorder to **PLAY (VCR)** mode and load a recorded cassette.
2. Open the menu and select **[AUDIO SET UP]**. Select **[AUDIO DUB.]**, set it to **[AUDIO IN]** or **[MIC. IN]** and close the menu.
3. Locate the scene you wish audio dubbing to start.
4. Press the **PAUSE** **||** button on the wireless controller.
5. Press the **AUDIO DUB.** button on the wireless controller.
 - “AUDIO DUB.” and “ **||** ” appear.
 - If the optional DM-50 microphone is attached, “ **☐** ” (Connection) appears.
6. Press the **PAUSE** **||** button on the wireless controller to begin dubbing.
 - Audio device: Begin playback.
 - Microphone: Direct your voice to the microphone.

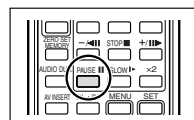
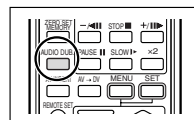

7. Press the STOP button on the wireless controller to stop dubbing.

Audio device: Stop playback.

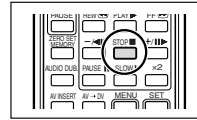

E



Set the zero set memory at the end of the scene you wish to dub audio. The camcorder will automatically stop audio dubbing at that point.

Playing Back the Added Sound



You can select to play back Stereo 1 (original sound), Stereo 2 (added sound), or adjust the balance of both sounds.

CAMERA

PLAY (VCR)

CARD CAMERA

CARD CAMERA

1. Press the 12bit AUDIO OUT button on the wireless controller.

- The setting changes with each press of the button.
- STEREO1: Plays back the original sound.
- STEREO2: Plays back the added sound.
- MIX/FIXED: Plays back stereo 1 and stereo 2 in the same level.
- MIX/VARI.: Plays back stereo 1 and stereo 2. The mix balance can be adjusted.

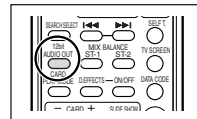

2. If you have selected [MIX/VARI.], adjust the mix balance with the ST-1/ST-2 buttons on the wireless controller.

- A bar showing the balance appears for 4 seconds.
- Press the ST-1 button to increase the volume of Stereo 1 and the ST-2 button to increase the volume of Stereo 2.

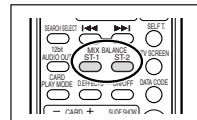

Editing



The camcorder resets to [STEREO1] when you turn the camcorder off. However, the mix balance is memorized by the camcorder.

Connecting to a Computer Using a DV (IEEE1394) Cable

E

You can transfer recordings to a computer equipped with a DV (IEEE1394) terminal or IEEE1394 capture board (optional software required).

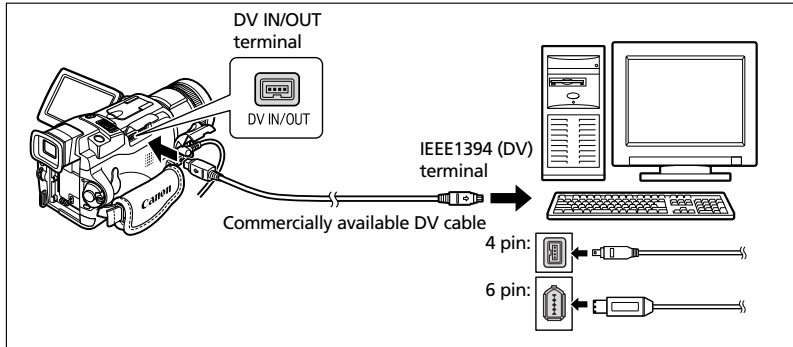

- Operation may not work correctly depending on the software and the specifications/settings of your computer.
- Do not disconnect the DV cable, open the memory card cover, remove the memory card, change the position of the POWER switch or turn off the camcorder and computer while data is being transferred to the computer (while the camcorder's card access indicator is flashing). Doing so may damage the memory card's data.
- The image file on your memory card and the image files saved on the hard disk drive of your computer are valuable, original data files. If you wish to use image files on your computer, make copies of them first, and use the copied file, retaining the original.
- If the computer freezes while you have connected the camcorder, disconnect and reconnect the DV cable. If the problem persists, disconnect the interface cable, turn off camcorder and computer, turn camcorder and computer back on and reconnect them.



- We recommend powering the camcorder from a household power source while it is connected to the computer.
- Refer also to the instruction manual of the computer.
- Optional software is required for transferring recordings from the tape to a computer. Refer to the instruction manual of the software.
- For transferring recordings from a memory card to the computer using a USB cable, see p. 139.
- Users of Windows XP can use the DV Network Software contained on the DIGITAL VIDEO SOLUTION DISK For Windows. For details, refer to the DV Network Software Instruction Manual.

Inserting and Removing the Memory Card

You can use **SD** SD Memory Cards or a commercially available MultiMediaCards with this camcorder. The SD Memory Card has a protect switch for prevent accidental erasure.

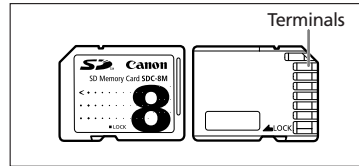

E



- This camcorder is compatible with SD Memory Cards or MultiMediaCards only.
 - Do not use any other types of memory cards.
- Turn off the camcorder before inserting or removing the memory card.
 - Otherwise, it may result in data damage.
- Do not touch the memory card terminals.
- If you use memory cards other than the supplied one, make sure to format them with the camcorder (☞ 138).
- For instructions on how to connect the camcorder to the computer, see *Connecting to a Computer Using a USB Cable* (☞ 139).

Inserting the Card

1. Turn off the camcorder.
2. Open the cover.
3. Insert the memory card all the way into the memory card slot.
4. Close the cover.

Do not close the cover forcefully without having the card correctly inserted.

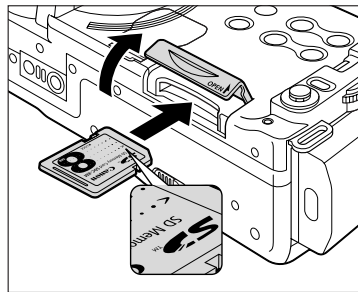

Removing the Card

Do not forcefully remove the memory card without first pushing it in.

1. Turn off the camcorder.
 - Make sure that the card access indicator is not flashing before you turn off the camcorder.
2. Open the cover.
3. Push the memory card to release it.
Remove the memory card.
4. Close the cover.

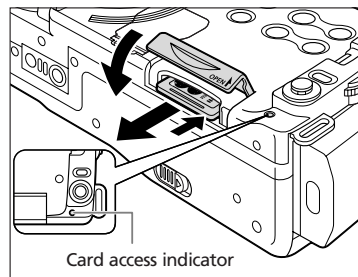

Selecting the Image Quality/Size



E

Changing the Still Image Quality

You can choose between Superfine, Fine and Normal.

CAMERA

PLAY (VCR)

CARD CAMERA

CARD PLAY (VCR)

MENU

(43)

CARD SET UP

SI QUALITY...FINE

Open the menu and select [CARD SET UP]. Select [SI QUALITY], set it to [SUPER FINE] or [NORMAL] and close the menu.

Changing the Still Image Size

You can choose between 1632 × 1224 pixels, 1280 × 960 pixels and 640 × 480 pixels.

CAMERA

PLAY (VCR)

CARD CAMERA

CARD PLAY (VCR)

MENU

(43)

CARD SET UP

SI SIZE.....1632×1224

Open the menu and select [CARD SET UP]. Select [SI SIZE], set it to [1280×960] or [640×480] and close the menu.



- Still images recorded in 1632 × 1224 pixels or 1280 × 960 pixels may not be displayed correctly in a camcorder not supporting this size.
- Still images are compressed and recorded in the JPEG (Joint Photographic Experts Group) format.
- Depending on subject and recording condition, changing the image quality may not show a significant difference.
- Estimated Capacity of a 8 MB Memory Card and File Size per Image:

Image Size \ Image Quality	1632 × 1224		1280 × 960		640 × 480	
	No. of Images	File Size per Image	No. of Images	File Size per Image	No. of Images	File Size per Image
Superfine	3	1360 KB	5	850 KB	34	175 KB
Fine	5	880 KB	9	550 KB	50	120 KB
Normal	10	480 KB	16	300 KB	84	65 KB

These figures are approximate. They vary according to the recording condition and the subject. Sample images already recorded on the supplied SD Memory Card are to be included in the total number.

- Remaining Image Capacity:
 - flashing in red: No card
 - in green: 6 or more images
 - in yellow: 1 to 5 images
 - in red: No more images

- The indication may not decrease even though a recording has been made, or may decrease by 2 images at once.
- All indicators are displayed in green when a memory card is played back.

Changing the Movie Size

You can choose between 352 × 288 pixels and 176 × 144 pixels.

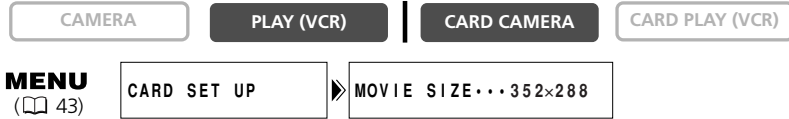

Open the menu and select [CARD SET UP]. Select [MOVIE SIZE], set it to [160 × 120] and close the menu.



- Movies are recorded in the MPEG-4 (Moving Picture Experts Group 4) format.
- Maximum recording time on a 8 MB memory card:

Image Size	Max. Recording Time (8 MB)	File Size per Second
352 × 288	approx. 2 min.	48 KB/sec.
176 × 144	approx. 6 min.	16 KB/sec.

File Numbers

Images are automatically assigned file numbers (still images: 0001 to 9900, movies: 001 to 999) and stored in folders (still images: 101 to 998, movies: 001 to 999) containing up to 100 images. (The sample images on the supplied memory card are saved in the [100canon] folder.)

You can choose to use consecutive file numbers (CONTINUOUS) or to reset the file number each time a different memory card is inserted (RESET). We recommend setting the file numbers to CONTINUOUS.

CONTINUOUS

The camcorder memorizes the file number of the last image and assigns the consecutive file number to the next image, even when a new memory card is inserted. (If a higher file number already exists on the memory card, the consecutive number will be assigned.) There will be no duplication of file numbers. This is useful for organizing images on a computer.

RESET

The file number will be reset each time a new memory card is inserted (starting at 101-0101 with still images and 001-101 with movies). If the memory card already contains image files, the consecutive file number will be assigned.

Still images:

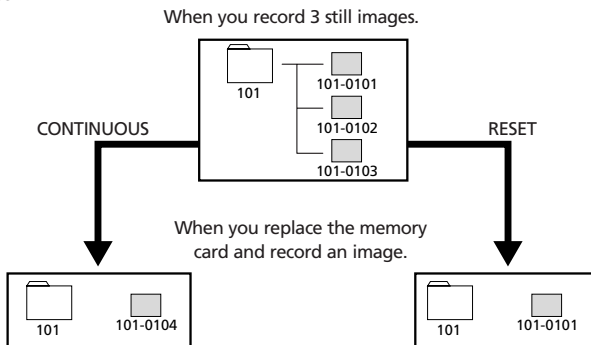

Movies:

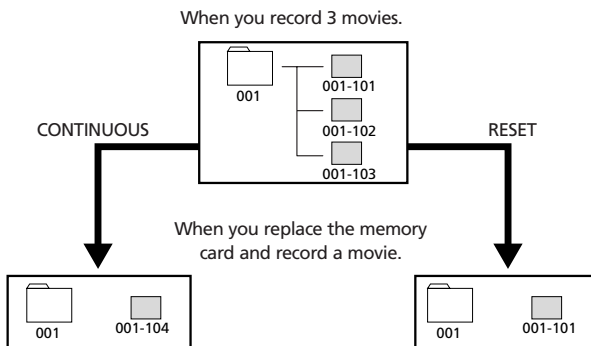

CAMERA

PLAY (VCR)

CARD CAMERA

CARD PLAY (VCR)

MENU



(43)

CARD SET UP

FILE NOS. . . . CONTINUOUS

To change the setting, open the menu and select [CARD SET UP]. Select [FILE NOS.], set it to [RESET] and close the menu.

Recording Still Images on a Memory Card

You can record still images with the camcorder, from a tape in the camcorder ( 115) or from devices connected via the DV terminal or AV terminal ( 116).

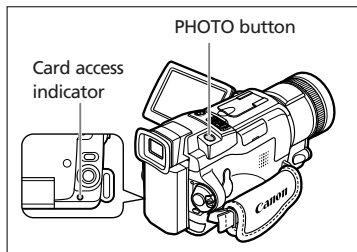

E



- Do not turn off the camcorder, disconnect the power source, open the memory card cover or remove the memory card while the card access indicator is flashing. Doing so could result in data damage.
- When you are using a SD Memory Card, make sure that the protect switch is set to allow recording.



- Make sure to insert a memory card with enough remaining capacity.
- The camcorder shuts off when you do not operate it for 5 minutes to save power. "  AUTO POWER OFF" appears 20 seconds before shutoff. To continue recording, turn the POWER switch to OFF and then back to CAMERA.
- We recommend saving the still images and movies on the memory card to a computer regularly.

Recording with the Camcorder

CAMERA

PLAY (VCR)

CARD CAMERA

CARD PLAY (VCR)

1. Set the camcorder to CARD CAMERA mode.

A white focusing frame appears in the center of the screen. The camcorder will focus on the subject in the center of the screen. To change the focusing point, see *Selecting the Focusing Point* ( 117).

2. Press the PHOTO button halfway.

-  and focusing frame turn green when focus is adjusted. The beep sounds twice. The picture may appear out of focus for a moment while the camcorder is focusing.
- Focus can be adjusted manually with the focus ring when the PHOTO button is pressed halfway.
- Exposure is locked.
- When you press the PHOTO button on the wireless controller, recording starts immediately.

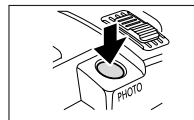



Using a Memory Card

3. Press the PHOTO button fully.

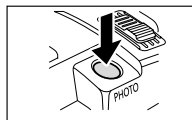
-  and focusing frame disappear and you hear a shutter sound.
- The card access indicator flashes and the card access display appears.
- The still image shown on the screen will be recorded on the memory card.



- To use the self-timer ( 74), press the  (self-timer) button before step 2 and press the PHOTO button fully.
- When the subject is too bright (overexposed), the ND filter turns on automatically ("ND" appears on the screen). If it is still too bright, "OVEREXP" starts flashing. In such case, use an optional ND filter. If you wish to turn off the ND filter: Open the menu and select [CAMERA SET UP]. Select [ND], set it to [OFF] and close the menu.
- "OVEREXP" does not appear when you lock the exposure with the EXP dial.
- **When the Focus-Priority mode is set to [ON]:**
If the subject is not suitable for autofocus, the focusing frame turns yellow and locks the focus. The confirmation sound beeps once. Adjust the focus manually with the focus ring.
- **When the focus-priority mode is set to [OFF]:**
No focusing frame appears.
In step 2,  turns green, and focus and exposure are locked.

Recording Still Images on a Memory Card While Recording Movies on a Tape

You can record still images on a memory card by pressing the PHOTO button while you are recording a movie on the tape.



- The size of the still image will be 640 × 480.
- You can use the full zoom range (11× optical zoom and 44×/220× digital zoom).
- The quality of the still image is slightly lower than a still image recorded in CARD CAMERA mode.
- Card mix and 16:9 mode cannot be used when [PHOTO REC] is set to [CARD ].
- The still image cannot be recorded on a memory card when a fader, effect or the multi-image screen is activated.
- The beep does not sound when you press the PHOTO button while recording a movie on the tape.



E

1. Open the menu and select [CAMERA SET UP]. Select [PHOTO REC], set it to [CARD] and close the menu.
2. While you are recording a movie, press the PHOTO button.
The image shown on the screen will be recorded on the memory card.

Recording from a Tape in the Camcorder

You can record images from a tape in the camcorder as still images on a memory card.



1. Set the camcorder to PLAY (VCR) mode.
2. Play back the tape.
3. Press the PHOTO button halfway when the scene you wish to record appears.
 - The camcorder pauses playback. The remaining image capacity and other information appear.
 - When you press the PHOTO button on the wireless controller, recording starts immediately.
4. Press the PHOTO button fully.
 - The card access indicator flashes.
 - The still image shown on the screen will be recorded on the memory card.
 - You can also record a still image by pressing the PHOTO button fully when the tape is in playback pause mode.



- A still image recorded from an image in 16:9 format will be vertically compressed.
- The data code of the still image will reflect the date and time it has been recorded on the memory card.
- There will be no shutter sound in PLAY (VCR) mode.
- The size of the still image will be 640 × 480.

Using a Memory Card

Recording from Other Video Devices

You can record images from devices connected via the S-video terminal or AV terminal (analog line-in function), or via the DV terminal as still images on a memory card.

E



When recording via the AV terminal, make sure that “AV→DV” is displayed on the screen. When recording via the DV terminal, make sure that “AV→DV” is not displayed. Change the setting as necessary (102).

CAMERA

PLAY (VCR)

CARD CAMERA

CARD PLAY (VCR)

1. Connect the camcorder to the video device.

- S-video/AV terminal: See *Playing Back on a TV Screen* (40).
- DV terminal: See *Connecting a Digital Video Device* (97).

2. Set the camcorder to PLAY (VCR) mode.

If a cassette is loaded, make sure the tape is stopped.

3. Connected device: Load a recorded cassette and play back the tape.

4. Press the PHOTO button halfway when the scene you wish to record appears.

- The still image, remaining image capacity and other information appear.
- When you press the PHOTO button on the wireless controller, recording starts immediately.

5. Press the PHOTO button fully.

- The card access indicator flashes.
- The still image shown on the screen will be recorded on the memory card.



- A still image recorded from an image in 16:9 format will be vertically compressed.
- The data code of the still image will reflect the date and time it has been recorded on the memory card.
- There will be no shutter sound in PLAY (VCR) mode.
- The size of the still image will be 640 × 480.

Selecting the Focusing Point

E

The subject you wish to record is not always in the center of the screen. In the Focus-priority mode, you can choose from one of three focusing points to automatically put the subject you wish into sharp focus.

When the mode dial is set to , the Focus-priority becomes set to ON (only the center focusing point is available).



The focusing frame gives an indication of the focusing point. Depending on the size of the subject or the distance, the camcorder may focus outside the frame.

CAMERA

PLAY (VCR)

CARD CAMERA

CARD PLAY (VCR)

1. Set the camcorder to CARD CAMERA mode.

A white focusing frame appears in the center of the screen.

2. Turn the mode dial to a position other than .

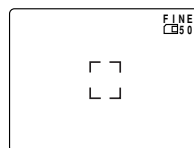

3. Turn the selector dial to display all focusing frames.

Three focusing frames appear on the screen, one of it in green.

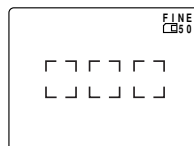

4. Turn the selector dial to select the focusing point.

Turn the selector dial up to select the frame to the right, down to select the frame to the left.

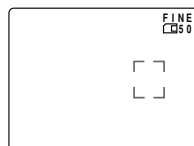

5. Press the PHOTO button halfway.

-  and focusing frame turn green when focus is adjusted. The beep sounds twice. The picture may appear out of focus for a moment while the camcorder is focusing.
- Focus can be adjusted manually with the focus ring when the PHOTO button is pressed halfway.
- Exposure is locked.
- When you press the PHOTO button on the wireless controller, recording starts immediately.

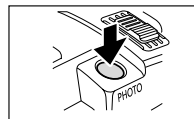

6. Press the PHOTO button fully.

-  and focusing frame disappear and you hear a shutter sound.
- The card access indicator flashes and the card access display appears.
- The still image shown on the screen will be recorded on the memory card.

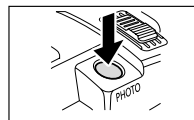

Using a Memory Card



- If you operate the zoom lever, press the EXP dial or do not press the PHOTO button within 4 seconds, the frames other than the selected one disappear.
- When you press the PHOTO button fully before ● and focusing frame turn green, ● and focusing frame turn yellow. It may take up to 4 seconds until focus is adjusted and the still image can be recorded to the memory card.
- The focusing point can be selected only when Focus-Priority is set to [ON] in CARD CAMERA mode.
- The focusing point returns to the center if you turn off the camcorder, change from CARD CAMERA mode or turn the mode dial to □.
- The focusing point cannot be selected in the following cases:
 - When focusing manually.
 - When using the digital zoom. When you zoom into the digital zoom range, the focusing frame flashes for 4 seconds and disappears. When you return to the optical zoom range, the focusing frame reappears.
 - When a shutter speed of 1/2 or 1/4 is selected in Tv mode.
 - In Stitch Assist mode.

Turning Off the Focus-Priority Mode



Turn off the Focus-Priority mode if you wish to put timing ahead of focus.

CAMERA

PLAY (VCR)

CARD CAMERA

CARD PLAY (VCR)

MENU

(43)

CAMERA SET UP

FOCUS PRI . . . ON

Open the menu and select [CAMERA SET UP]. Select [FOCUS PRI.], set it to [OFF] and close the menu.

Selecting the Drive Mode



You can choose between three drive modes (recording modes).

E

Continuous	Captures a quick series of still images while you press the PHOTO button.
AEB (Auto Exposure Bracketing)	Captures a still image in three different exposures just by pressing the PHOTO button once.
Single	Records a single still image when you press the PHOTO button.

Continuous Shooting

You can capture a quick series of still images with the continuous shooting function.

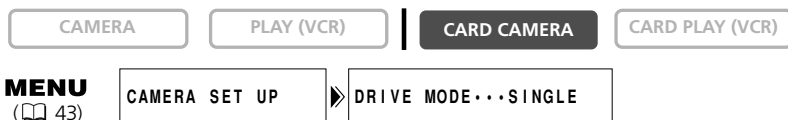

1. Set the camcorder to **CARD CAMERA** mode.
2. Open the menu and select **[CAMERA SET UP]**. Select **[DRIVE MODE]**, set it to **[CONT. **

○ Maximum number of continuous shots at one time:

Still Image Size	Built-in flash	Frames per Second	Maximum Number of Continuous Shots
1632 × 1224	Flash OFF/ON	2 frames	10 images
1280 × 960	Flash OFF	3 frames	10 images
	Flash ON	2 frames	10 images
640 × 480	Flash OFF	3 frames	30 images
	Flash ON	2 frames	30 images

* These figures are approximate and vary with the recording conditions and subjects. Sufficient space on the memory card is required. Continuous shooting stops when card is full.

- This function can be assigned to the **CSTM KEY** ( 53).
- The range of the flash decreases in continuous shooting mode. We recommend recording close to the subject when using the flash.

Auto Exposure Bracketing

With Auto Exposure Bracketing (AEB), the camcorder records a still image in three different exposures (dark, normal, light in 1/2 EV steps), allowing you to choose the perfect exposed shot.

E



1. Set the camcorder to **CARD CAMERA** mode.
2. Open the menu and select **[CAMERA SET UP]**. Select **[DRIVE MODE]**, set it to **[AEB **] and close the menu.

"" appears on the screen.

3. Press the **PHOTO** button.

Three still images in different exposures are recorded to the memory card.



- This function can be assigned to the **CSTM KEY** ( 53).
- The flash cannot be used during auto exposure bracketing.
- Make sure that there is sufficient space on the memory card.

Recording Panoramic Images (Stitch Assist Mode)

You can shoot a series of overlapping images and merge them into one large panoramic scene using the supplied software (PhotoStitch) on a computer.

E

When Recording in Stitch Assist Mode:

PhotoStitch detects the overlapping portion of adjoining images and merges them. Try to include a distinctive item (landmark, etc.) in the overlapping portion.



1. Set the camcorder to **CARD CAMERA** mode.

2. Press the  button.



3. Select the direction with the **CARD +/-** button.

CARD + button: clockwise. CARD - button: counterclockwise.

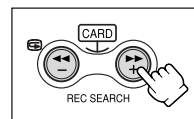

4. Select the program **AE mode** and zoom on the subject.

Adjust focus and exposure manually as necessary. Once the sequence has started, you cannot change the program AE mode, exposure, zoom or focus.

5. Press the **PHOTO** button to record the first image.

Direction and number of recorded images appear.

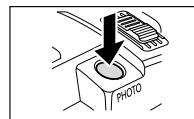

6. Record the second image so that it overlaps a portion of the first image.

- Minor discrepancies in the overlapped area can be corrected with the software.
- You can retake an image by pressing the CARD +/- button to return to the previous image.
- A maximum of 26 images can be recorded.

7. Press the  button after the last image.

For details on how to merge these images, refer to the Digital Video Software Instruction Manual.





- Compose each image so that it overlaps 30 to 50% of the adjoining image. Try to keep the vertical misalignment within 10%.
- Do not include moving subject in the overlapping portion.
- Do not try to stitch images that include both distant and close subjects. They may appear warped or doubled up.
- The continuous shooting mode cannot be used in Stitch Assist mode.

E

Recording MPEG-4 Movies on a Memory Card

You can record MPEG-4 movies with the camcorder or from a tape in the camcorder ( 124).

E



- Do not turn off the camcorder, disconnect the power source, open the memory card cover or remove the memory card while the card access indicator is flashing. Doing so could result in data damage.
- When you are using a SD Memory Card, make sure that the protect switch is set to allow recording.
- Do not load/unload a cassette during recording.



- Make sure to insert a memory card with enough remaining capacity.
- We recommend saving the still images and movies on the memory card to a computer regularly.
- We recommend a file size of 1 MB (352 × 288: approx. 20 sec., 176 × 144: approx. 60 sec.) if you plan to attach the MPEG-4 movie to an e-mail message.
- The sound of a movie recorded on a memory card will be monaural.
- You can select the focusing point when recording a movie on the memory card with the camcorder.

Recording with the Camcorder

CAMERA

PLAY (VCR)

CARD CAMERA

CARD PLAY (VCR)

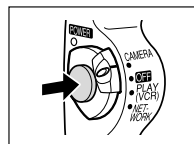

1. Set the camcorder to **CARD CAMERA** mode.
2. Press the start/stop button to begin recording.

You can keep recording until "CARD FULL" appears.



3. Press the start/stop button to stop recording.



To use the self-timer ( 74), press the  (self-timer) button before step 2 and press the start/stop button.

Recording from a Tape in the Camcorder

You can record movies from a tape in the camcorder on a memory card.

E

CAMERA

PLAY (VCR)

CARD CAMERA

CARD PLAY (VCR)

1. Set the camcorder to **PLAY (VCR)** mode.
2. Play back the tape.
3. Press the start/stop button when the scene you wish to record appears.
You can keep recording until "CARD FULL" appears.
4. Press the start/stop to stop recording.



- A movie recorded from an image in 16:9 format will be vertically compressed.
- The data code of the movie will reflect the date and time it has been recorded on the memory card.
- Recording stops at blank sections or recordings in different audio mode (12bit/16bit).

Playing Back a Memory Card



You can play back memory card images on the LCD screen, viewfinder screen, or on a connected TV screen (see *Playing Back on a TV Screen* [40]).

E

You can display a single image, 6 at one time (index screen [126), or one after another (slide show [127). Use the Card Jump function to quickly locate an image without displaying them one by one ([127).



- Images not recorded with this camcorder, uploaded from a computer (except the sample images [142), edited on a computer and images whose file names have been changed may not be played back correctly.
- Do not turn off the camcorder, disconnect the power source, open the memory card cover or remove the memory card while the card access indicator is flashing. Doing so could result in data damage.



- Make sure to insert a memory card that contains images.
- Only date and time will be displayed when pressing the FOCUS A/M button (data code).
- You can enlarge still images up to 5 times during playback ([91).

Playing Back Still Images (Still Image Playback Mode)

Still images are played back in the still image playback mode.

CAMERA

PLAY (VCR)

CARD CAMERA

CARD PLAY (VCR)

1. Set the camcorder to CARD PLAY (VCR) mode.

- The camcorder displays the still image playback mode.
- The last recorded image appears.

2. Press the CARD +/- button to move between images.

Press the CARD + button to display the next image and the CARD – button to display the previous image.

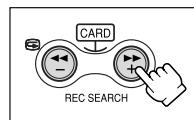

Using a Memory Card

Playing Back MPEG-4 Movies (Movie Playback Mode)

Movies are played back in the movie playback mode.

E

CAMERA

PLAY (VCR)

CARD CAMERA

CARD PLAY (VCR)

1. Set the camcorder to **CARD PLAY (VCR)** mode.
2. Press the **CARD STILL/MOVIE** button.

- The camcorder displays the movie playback mode.
- The last recorded movie appears with the first scene as a still image.
- Pressing the **CARD STILL/MOVIE** button takes you back to the still image playback mode.



3. Press the **CARD +** button to display the next movie and the **CARD -** button to display the previous movie.

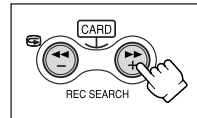

4. Press the **▶/||** button to play back the movie.

- The first scene appears as a still image when playback is complete.
- Pressing the **▶/||** button during playback pauses the playback. Press the **▶/||** button again to restart playback.
- Pressing the **■** button displays the first scene of the movie.
- Press the **CARD +** button for fast forward playback and the **CARD -** button for fast reverse playback.

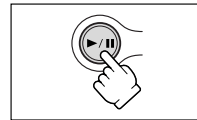

- Movies recorded in Motion JPEG format with another Canon camcorder will be displayed in still image playback mode (indicated with **▶/||**). The **■** button cannot be used during playback of Motion JPEG movies.
- Movies not recorded with this camcorder may not be played back correctly.

Using a Memory Card

Index Screen



In movie playback mode, the index screen can be displayed when **▶/||** is shown on the lower right of the movie.

CAMERA

PLAY (VCR)

CARD CAMERA

CARD PLAY (VCR)

For movies, press the **CARD STILL/MOVIE** button.

1. Move the zoom lever toward **W**.
Up to 6 images appear.

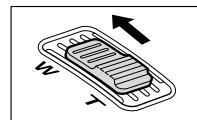

2. Press the CARD +/- button to change the image selection.

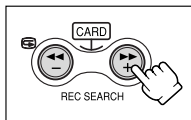

3. Move the  mark to the image you wish to view.

- Turn the selector dial up to move to the next image and down to move to the previous image.
- Turning the selector dial up on the last image displays the next index screen. Turning the selector dial down on the first image displays the previous index screen.



4. Move the zoom lever toward T.

The index screen is canceled.

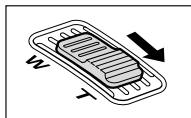

Slide Show



For movies, press the CARD STILL/MOVIE button.

1. Press the SLIDE SHOW button.

Images are played back one after another.



2. Press the SLIDE SHOW button to stop the slide show.

Card Jump Function

You can locate still images/movies without displaying them one by one. The number in the upper right of the screen indicates the image number of the current image by the total number of images.



In movie playback mode, card jump can be activated when  is shown on the lower right of the movie.



For movies, press the CARD STILL/MOVIE button.

Press and hold the CARD + or CARD – button.

- Press the CARD + button to jump forward and the CARD – button to jump backward.
- When you release the button, the still image/movie of the displayed image number appears.

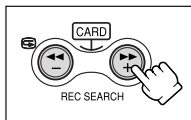

Protecting Images



E

You can protect important images from accidental erasure when displaying a single image or index screen.



If a memory card is formatted, all still images and movies, even protected ones, will be erased permanently.





- The sample images recorded on the supplied SD Memory Card are already protected.
- In movie playback mode, movies can be protected when  is shown on the lower right of the movie.
- Make sure to insert a memory card that contains images.

CAMERA

PLAY (VCR)

CARD CAMERA

CARD PLAY (VCR)

1. Select the image you wish to protect.
2. Press the selector dial to open the FILE OPERATION menu.
3. Select [PROTECT ].
 - “” appears and now the image cannot be erased.
 - To cancel the protection, press the selector dial.
4. Select [ RETURN] to close the menu.

Protecting during Index Screen Display

CAMERA

PLAY (VCR)

CARD CAMERA



CARD PLAY (VCR)

MENU

( 43)

CARD OPERATIONS

 PROTECT 

1. Move the zoom lever toward W.
Up to 6 images appear.
2. Open the menu and select [CARD OPERATIONS].
3. Select [ PROTECT ].
4. Select the image you wish to protect and press the selector dial.
 - “” appears on the image.
 - Repeat this step to protect more images.
 - To cancel the protection, press the selector dial.
5. Press the MENU button.



To cancel the protection, press the selector dial in step 4. “” disappears and the image can now be erased.

Erasing Images



You can erase images singly or all at once.

E



Be careful when erasing images. Erased images cannot be recovered.



- Protected images cannot be erased.
- When you select to erase all images, only those images in the respective playback mode (still image or movie) will be erased.
- In movie playback mode, movies can be erased when  is shown on the lower right of the movie.
- Make sure to insert a memory card that contains images.

Erasing a Single Image



1. Select the image you wish to erase.
2. Press the selector dial to open the FILE OPERATION menu.
3. Select [IMAGE ERASE].
 - “ERASE THIS IMAGE?”, [NO] and [YES] appears.
 - If an image is protected, [YES] appears in purple.
4. Select [YES].

The image is erased and the previous image appears.
5. Select [ RETURN] to close the menu.

Erasing a Single Image/All Images



1. Open the menu and select [CARD OPERATIONS].
2. Select [IMAGE ERASE].
3. Select [SINGLE] or [ALL].
 - When erasing a single image: “ERASE THIS IMAGE?” [NO] and [YES] appears. If an image is protected, [YES] appears in purple.
 - When erasing all images: “ERASE ALL IMAGES? [EXCEPT FOR  IMAGES]”, [NO] and [YES] appears.
4. Select [YES] and close the menu.
 - When erasing a single image: The image is erased and the previous image appears. To erase another image, select the image with the CARD +/- button and select [YES].
 - When erasing all images: All still images or movies with exception of the protected ones are erased.

Selecting Still Images for Printing (Print Order)

E

You can select still images for printing and set the number of copies. These print order settings are compatible with the Digital Print Order Format (DPOF) standards and can be used for printing on DPOF compatible Canon printers and PictBridge-compliant printers.





- Make sure to insert a memory card that contains images.
- A maximum of 200 still images can be selected.
- Movies cannot be printed.

CAMERA

PLAY (VCR)

CARD CAMERA

CARD PLAY (VCR)

1. Select the still image you wish to print.
2. Press the selector dial to open the FILE OPERATION menu.
3. Select [ PRINT ORDER].
4. Select the number of copies.
 - " " appears on the image.
 - To cancel the print order, set the number of copies to 0.
5. Select [ RETURN] to close the menu.

Selecting in Index Screen Display

CAMERA

PLAY (VCR)

CARD CAMERA

CARD PLAY (VCR)



MENU

( 43)

CARD OPERATIONS



 PRINT ORDER

1. Move the zoom lever toward W.
 - Up to 6 images appear.
2. Open the menu and select [CARD OPERATIONS].
3. Select [ PRINT ORDER].
4. Select the still image you wish to print and press the selector dial.
5. Set the number of copies with the selector dial and close the menu.
 - " " appears on the image.
 - To cancel the print order, set the number of copies to 0.
 - Repeat steps 4 and 5 to continue the print order setting.

Erasing All Print Orders

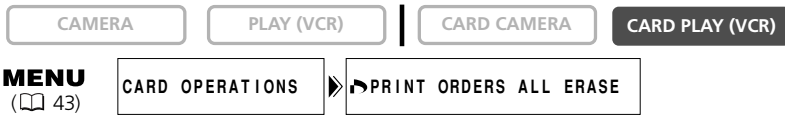

E

1. Open the menu and select [CARD OPERATIONS].
2. Select [**▶** PRINT ORDERS ALL ERASE].
"ERASE ALL **▶** PRINT ORDERS?", [NO] and [YES] appears.
3. Select [YES].
All "**▶**" disappear.
4. Select [**◀** RETURN] to close the menu.

Combining Images (Card Mix)



E

You can produce effects not possible with just a tape with the Card Mix function. Choose one of the sample images provided on the supplied SD Memory Card (such as picture frames, backgrounds and animations) and combine it with the live video recording.



- Card mix cannot be used when [PHOTO REC] is set to [CARD ].
- Movies recorded on a memory card cannot be combined with camcorder recordings.
- Make sure to load a cassette and to insert a memory card that contains card mix images.
- Additional sample images are provided on the supplied DIGITAL VIDEO SOLUTION DISK. For instructions on how to upload them to the memory card, refer to *Adding Still Images from Your Computer to the Memory Card* in the Digital Video Software Instruction Manual.
- Reselect the card mix image when you have turned off the camcorder.

Card Mix Effects

You can select from the following 4 types of Card Mix effects:

Card Chroma Key (CARD CHROMA)

Combines frames with your recordings. The live video recording will appear in place of the blue area of the card mix image. If you create your own frame, make sure that the area the live recording should appear is blue.

Mix level adjustment: blue area of the still image.



Card Luminance Key (CARD LUMI.)

Combines illustrations or title with your recordings. The live video recording will appear in place of the light area of the card mix image. You can create your own title or illustration by drawing on a white paper and recording it to the memory card. Mix level adjustment: light area of the still image.



Camera Chroma Key (CAM. CHROMA)

Combines backgrounds with your recordings. Record your subject in front of a blue curtain, and the subject not blue will be superimposed on the card mix image. Mix level adjustment: blue area of the live video recording.

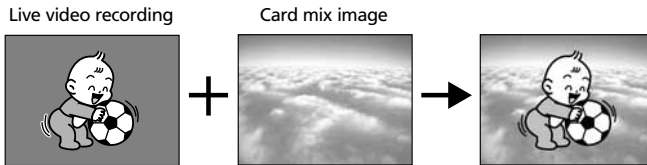

Card Animation (C. ANIMATION)

Combines animations with your recordings. You can choose from 3 types of card animation effects. Corner: Animation appears on the upper left and the lower right corner of the screen. Straight: Animation appears on the top and bottom of the screen and moves to the right and left. Random: Animation moves randomly in the display. Mix level adjustment: blue area of the card animation image.

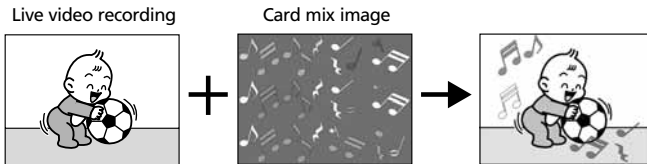

Selecting the Card Mix Effect

E

CAMERA

PLAY (VCR)

CARD CAMERA

CARD PLAY (VCR)

MENU

(43)

➔CARD MIX

▶MIX TYPE.....CARD CHROMA▶▶

MIX LEVEL.....+

1. Turn the mode dial to a position other than .

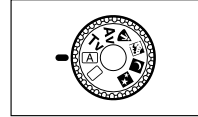

2. Open the menu and select **[➔CARD MIX]**.

The card mix menu appears.

3. Select the image you wish to combine with the **CARD +/-** button.



4. Select **[MIX TYPE]**.

[CARD CHROMA], [CARD LUMI.], [CAM. CHROMA] and [C. ANIMATION] appears.

5. Select the mix type matching the image you have selected (142).

- The screen shows the combined image.
- When you have selected [C. ANIMATION], select [ANIMAT. TYPE] and select between [CORNER], [STRAIGHT] and [RANDOM].

6. To adjust the mix level, select **[MIX LEVEL]** and adjust it with the selector dial.

7. Close the menu.

"CARD MIX" flashes.



Using a Memory Card

Activating the Card Mix Effect

1. Press the **CARD MIX** button.

- "CARD MIX" stops flashing.
- The combined image appears.
- You can activate and deactivate the card mix effect by pressing the CARD MIX button.



Recording with the Card Mix Effect

Movie:

1. Press the start/stop button to begin recording.

The combined image is recorded on the tape.

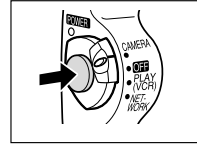

E

2. Press the start/stop button to end recording.

Still Image:

1. Press the PHOTO button halfway.

- flashes in white and turns green when focus is adjusted.

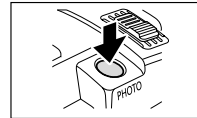

2. Press the PHOTO button fully.

- The camcorder records the still image on the tape for approx. 6 seconds. During this time, the camcorder displays the still image and keeps recording the sound.
- The camcorder returns to record pause mode.

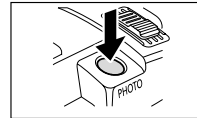

Copying Still Images



E

You can copy still images from tape to memory card, or from memory card to tape.



- All still images from the selected still image onward will be copied.
- The size of a still image copied from tape to memory card will be 640 × 480.
- The data code of the still image reflects the date and time it has been copied.

Copying Still Images from Tape to Memory Card

Insert a memory card with enough remaining capacity, and load a recorded cassette.

CAMERA

PLAY (VCR)

CARD CAMERA

CARD PLAY (VCR)

MENU

(43)

CARD OPERATIONS

COPY [→]

1. Locate the still image you wish to copy on the tape and stop the tape shortly before the still image.

- You can also use the photo search function to easily locate the still image.
- To copy all still images from the tape, rewind the tape to the beginning.

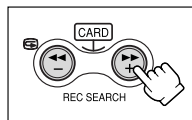

2. Open the menu and select [CARD OPERATIONS].

3. Select [COPY [→]].

[CANCEL] and [EXECUTE] appears.

4. Select [EXECUTE].

- "NOW COPYING" appears.
- The still image being copied is shown on the screen.
- Copying stops when the tape reaches the end or the memory card is full ("CARD FULL" appears).



5. Press the (stop) button to end copying.

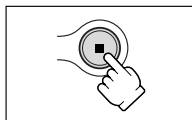

Copying Still Images from Memory Card to Tape

Load a cassette with enough free space, and insert a recorded memory card. Make sure that the protect tab on the cassette is set to allow recording.



MENU
(43)

CARD OPERATIONS

COPY [→]

1. Select the first still image you wish to copy with the **CARD +/-** buttons.

To copy all still images from the memory card, select the first still image.

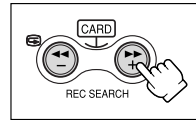

2. Open the menu and select **[CARD OPERATIONS]**.

3. Select **[COPY [→]]**.

[CANCEL] and [EXECUTE] appears.



4. Select **[EXECUTE]**.

- "NOW COPYING" appears.
- It takes about 6 seconds per still image to be copied to the tape.
- Copying stops when all still images are copied or the tape is full.

5. Press the (**stop**) button to end copying.

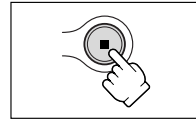

E

Formatting a Memory Card



E

Format new memory cards, or when you get the message "CARD ERROR". You can also format a memory card to erase all images recorded on it.

The camcorder formats memory cards in the Design rule for Camera File system (DCF) standard.



- Formatting a memory card erases all data, including protected images.
- Images erased by formatting cannot be recovered.
- If you use a memory card other than the supplied one, format it with the camcorder.
- Makes sure to insert the memory card you wish to format into the camcorder.



MENU

(43)

CARD OPERATIONS

▶▶ FORMAT

1. Open the menu and select [CARD OPERATIONS].

2. Select [FORMAT].

[CANCEL] and [EXECUTE] appears.

3. Select [EXECUTE].

[ALL DATA WILL BE ERASED. FORMAT THIS CARD?], [NO] and [YES] appears.

4. Select [YES] and close the menu.

- Formatting starts.
- Selecting [NO] brings you back to step 3.

Connecting to a Computer Using a USB Cable

You can download images from the memory card to a computer using the supplied USB cable.

E



- Do not disconnect the USB cable, open the memory card cover, remove the memory card, change the position of the POWER switch or turn off the camcorder and computer while data is being transferred to the computer (while the camcorder's card access indicator is flashing). Doing so may damage the memory card's data.
- Operation may not work correctly depending on the software and the specifications/settings of your computer.
- The image file on your memory card and the image files saved on the hard disk drive of your computer are valuable, original data files. If you wish to use image files on your computer, make copies of them first, and use the copied file, retaining the original.



- We recommend powering the camcorder from a household power source while it is connected to the computer.
- Refer also to the computer instruction manual.
- Still images/movies recorded on a tape cannot be transferred to a computer via USB interface.
- For transferring recordings from to a computer using a DV cable, see p. 108.
- Users of Windows XP and Mac OS X:
Your camcorder is equipped with the standard Picture Transfer Protocol (PTP) allowing you to download still images (JPEG only) by simply connecting the camcorder to a computer via USB cable without installing the software from the DIGITAL VIDEO SOLUTION DISK.
- Users of Windows XP can use the DV Network Software contained on the DIGITAL VIDEO SOLUTION DISK For Windows. For details, refer to the DV Network Software Instruction Manual.

Selecting the USB Connection Mode



You can choose between [STANDARD] and [STORAGE] mode when connecting the camcorder to a computer using the USB cable.

[STANDARD]

The camcorder automatically selects the correct mode for downloading still images or MPEG-4 movies to the computer. When downloading or printing still images, set the camcorder to still image playback mode and connect it to a computer or a printer. When downloading movies, set the camcorder to movie playback mode and connect it to a computer.

We recommend setting the USB connection mode to [STANDARD].

[STORAGE]

When the camcorder is set to [STORAGE], it will be recognized as [Removable Disk] (USB mass storage device) by the computer. You can use the camcorder like a card reader/writer and download/upload still images and movies to/from the computer without installing the provided software (e.g. using Windows Explorer). Still images are saved in the [***CANON] folder of the [DCIM] folder, and movies are saved in the [PRL***] folder of the [SD_VIDEO] folder.



Do not connect the camcorder to a printer when [USB CONNECT] is set to [STORAGE], or in movie playback mode when [USB CONNECT] is set to [STANDARD] mode.

E



- In [STANDARD] mode, install the software provided on the DIGITAL VIDEO SOLUTION DISK when downloading still images to a computer. With the software, you can browse and archive images or arrange still images for printout.
- Users of Windows 98 must install the DVC Storage Driver from the DIGITAL VIDEO SOLUTION DISK For Windows when downloading movies to a computer in [STANDARD] mode or when you have set the camcorder to [STORAGE] mode. With Windows Me/Windows 2000/Windows XP, an OS standard driver will be installed automatically.
- For details on the DIGITAL VIDEO SOLUTION DISK, refer to the Digital Video Software Instruction Manual.

CAMERA

PLAY (VCR)

CARD CAMERA

CARD PLAY (VCR)

MENU

(43)

SYSTEM

▶ USB CONNECT •• STANDARD

Open the menu and select [SYSTEM]. Select [USB CONNECT], set it to [STORAGE] and close the menu.

Connection

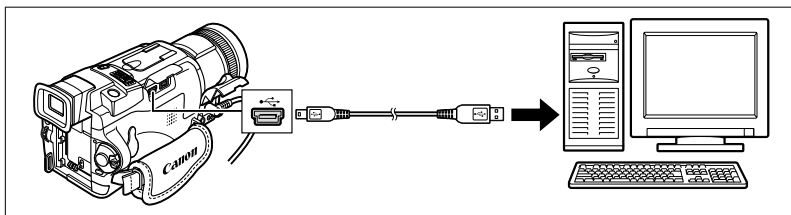

"PC CONNECT  " appears to indicate that the camcorder is connected to the computer via USB cable.

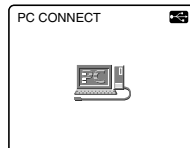

Memory Card Information

Images recorded on a memory card with this camcorder can be transferred to a computer using the following products for SD Memory Cards or MultiMediaCards:

E

PC Card Adapter: An adapter to insert a memory card into the card slot on the computer.

USB Reader/Writer: Connects to the USB port of a computer for direct access to the memory card.

Memory Card Handling Precautions

- Format new memory cards with the camcorder. Memory cards formatted with other devices such as a computer may not operate correctly.
- We recommend saving backups of memory card images on your computer's hard drive or other external memory device. Image data may be corrupted or lost due to memory card defects or exposure to static electricity. Canon Inc. makes no warranties for corrupted or lost data.
- Do not turn off the camcorder, disconnect the power source, open the memory card cover or remove the memory card while the card access indicator is flashing.
- Do not use memory cards in places subject to strong magnetic fields.
- Do not leave memory cards in places subject to high humidity and high temperature.
- Do not disassemble memory cards.
- Do not bend, drop, or subject memory cards to shocks and do not expose them to water.
- Moving a memory card rapidly between hot and cold temperatures may cause condensation to form on its external and internal surfaces. If condensation forms on the card, put it aside until the droplets have evaporated completely.
- Do not touch or expose the terminals to dust or dirt.
- Store and carry memory cards in the supplied case to protect the terminals.
- Check the direction before inserting the memory card. Forcing a memory card backwards into the slot may damage the memory card or the camcorder.
- Do not remove the label from the memory card, or affix other labels on the memory card. If you wish to add labels, affix them to the case.

Sample Images

27 sample images are pre-recorded on the supplied SD Memory Card: 8 card chroma key images, 5 card luminance key images, 2 camera chroma key images and 12 card animation images.

E

Card Chroma Key

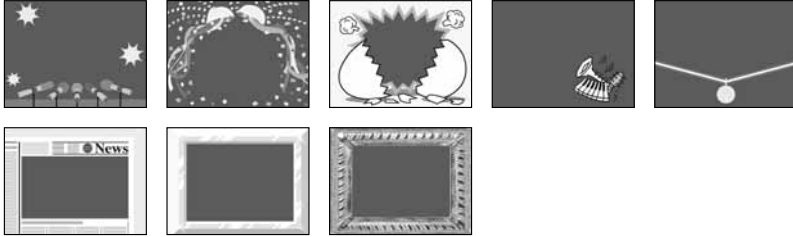

Card Luminance Key



Camera Chroma Key

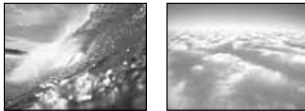

Card Animation

Using a Memory Card

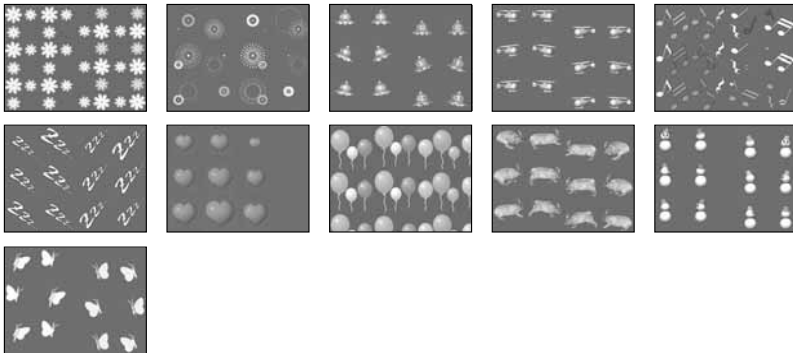



The sample images recorded on the supplied SD Memory Card are intended only for the personal use with this camcorder. Do not use these sample images for other purposes.



If you have mistakenly erased the sample images on the supplied SD Memory Card, they can be downloaded from the homepage <http://www.canondv.com>. For details on how to add the downloaded images to the memory card, refer to *Adding Still Images from Your Computer to the Memory Card* in the Digital Video Software Instruction Manual.

If you cannot use the USB cable to connect the camcorder to a computer, you will need a PC Card Adapter to upload the images to a memory card.

E

PhotoEssentials – Royalty Free Stock Photography



The PhotoEssentials suite of royalty-free images on CD-ROM features premium quality assignment photography and is ideally suited for use in advertising, brochures, reports, multimedia, websites, books, packaging and more.

For more information, please visit their website www.photoessentials.com

Printing Still Images (Direct Printing)

E

You can print still images by connecting the camcorder to a printer with Direct Print function or to a PictBridge-compliant printer. You can also use the print order settings for direct printing ( 130).

You can connect Canon Card Photo Printers with the  logo, Canon Bubble Jet Printers with the  logo and printers with the  PictBridge logo.



- Observe the following precautions during printing, otherwise printing may not be performed correctly.
 - Do not turn off the camcorder or the printer.
 - Do not change the position of the TAPE/CARD switch.
 - Do not detach the cable.
 - Do not open the memory card cover or remove the memory card.
- Do not connect the camcorder to a printer when [USB CONNECT] is set to [STORAGE], or in movie playback mode when [USB CONNECT] is set to [STANDARD] mode.
- Do not connect the camcorder to a printer when the camcorder is set to NETWORK mode.
- Still images not recorded with this camcorder or edited on the computer may not be printed correctly on a Bubble Jet Printer with direct print function.



- Refer to the instruction manual of each printer for information on which interface cable to use with the camcorder.
 - The Card Photo Printers CP-10 and CP-100 are supplied with two direct interface cables. Use the cable with the USB logo on the connector (DIF-100).
- We recommend powering the camcorder from a household power source.
- Refer also to the instruction manual of the respective printer.

Connecting the Printer to the Camcorder

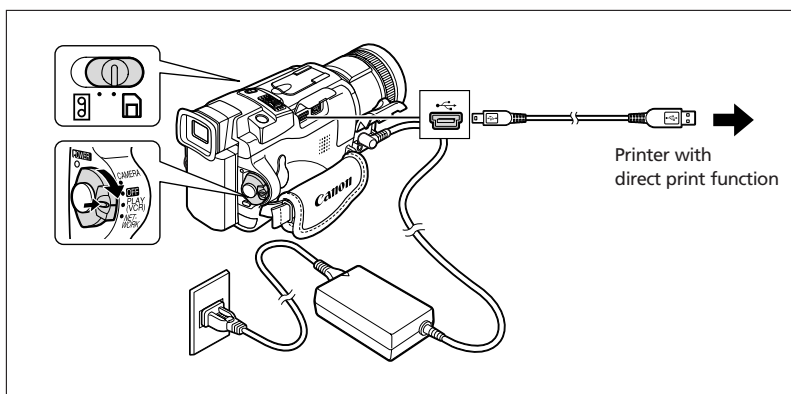



Direct Printing

1. Turn off the camcorder and insert a memory card that contains still images.
2. Connect a power source to the printer and turn on the printer.

3. Set the camcorder to CARD PLAY (VCR) mode.

Wait until the card access indicator stops flashing.

4. Connect the camcorder to the printer using the cable.

 appears and changes to   when the printer is properly connected to the camcorder. (Does not appear with movies, or still images that cannot be played back with the camcorder.)

E



- If  continues to flash (for more than 1 minute), the USB connection mode is not correctly set in the menu, or the camcorder is not correctly connected to the printer. In such case, 1) open the menu and make sure that [USB CONNECT] is set to [STANDARD], and 2) disconnect the cable from camcorder and printer, turn off camcorder and printer, turn both back on and reconnect the camcorder to the printer.
- Do not press the CARD STILL/MOVIE button while a printer is connected to the camcorder.

Printing

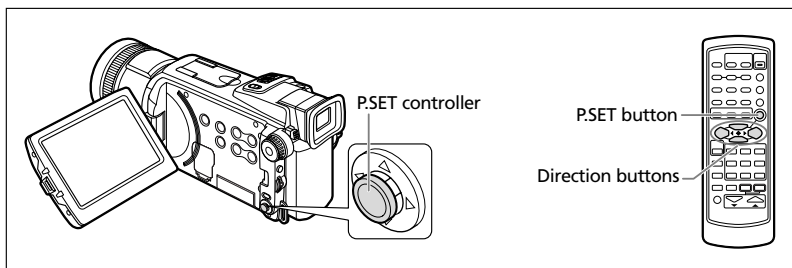

CAMERA

PLAY (VCR)

CARD CAMERA

CARD PLAY (VCR)

1. During still image playback, select the still image you wish to print and press the controller in.

- The print setting menu appears.
- Depending on the printer, the message "Printer warming up" may appear before the camcorder displays the print setting menu.



2. Select the print settings (147).

3. Select [PRINT] and press the controller in.

Printing starts. The print setting menu disappears when printing is complete.

Direct Printing



○ **Cancel Printing**

Press the controller in while "NOW PRINTING" is displayed. A confirmation dialog appears. Select [OK] and press the controller in. Printing stops even if it is incomplete and the paper is fed through.

○ **Printing Errors**

- If an error occurs during the printing process, an error message appears (□ 159).
- Bubble Jet Printer: With most errors, printing resumes automatically after you correct the error. If the error persists, press the controller in to cancel printing. Refer also to the Bubble Jet Printer Quick Start Guide for details.
- Card Photo Printer: Select [STOP] or [RESTART] and press the controller in. (The [RESTART] setting may not appear with some error messages. In that case, select [STOP].) Refer also to the Card Photo Printer User Guide for details.
- If the error persists and printing does not restart, follow below procedure:
 1. Disconnect the cable.
 2. Turn the POWER switch of the camcorder to OFF and back to PLAY (VCR).
 3. Reconnect the cable.

○ **When you have finished printing:**

1. Disconnect the cable from the camcorder and printer.
2. Turn off the camcorder.

Selecting the Number of Copies

A maximum of 9 copies can be selected for one still image.









1. In the print setting menu, turn the controller up to select [COPIES] and press the controller in.
2. Turn the controller up or down to select the number of copies and press the controller in.



Selecting the Print Settings (Style/Paper Settings)

Check which print setting menu your camcorder displays and move to the respective section. The print setting options vary depending on the printer.

E

Setting Options	Canon Card Photo Printers 	Canon Bubble Jet Printers 	PictBridge-compliant Printer 
Print Setting Menu	 Print Setting Menu ① →  147	 Print Setting Menu ② →  148	 Print Setting Menu ③ →  149
Image Style	<input type="radio"/>	<input checked="" type="radio"/>	<input checked="" type="radio"/>
Paper Size	<input checked="" type="radio"/>	<input type="radio"/>	<input type="radio"/>
Paper Type	<input checked="" type="radio"/>	<input checked="" type="radio"/>	<input type="radio"/>
Borders*	<input type="radio"/>	<input type="radio"/>	<input type="radio"/>
Date	<input checked="" type="radio"/>	<input checked="" type="radio"/>	<input type="radio"/>
Trimming	<input type="radio"/>	<input type="radio"/>	<input type="radio"/>

* Bordered: The image area remains relatively unchanged from the recorded image when it is printed.

* Borderless: The center portion of the recorded image is printed at an enlarged size. The image's top, bottom and sides may be cropped slightly.

Print Setting Menu 1

Image	Standard	Prints 1 still image per page.
	Multiple	Prints 8 copies of the same still image on one page.
Borders	Borderless	Prints right to the edges of the page.
	Bordered	Prints with a border.

- [Multiple] can only be selected when printing on card size paper. The center portion of the recorded image is printed at an enlarged size. The image's top, bottom and sides may be cropped slightly.
- [Borders] can only be selected when [Image] is set to [Standard].

1. In the print setting menu, turn the controller up to select [STYLE] and press the controller in.

Direct Printing

Selecting the Image Style

2. Make sure that  (Image) is selected and press the controller in.
3. Press the controller to the right or left to select the image style and press the controller in.

Pressing the MENU button brings you back to the print settings menu.



Selecting the Borders

2. Press the controller to the right or left to select  (Borders) and press the controller in.
3. Press the controller to the right or left to select a borders option and press the controller in.

Pressing the MENU button brings you back to the print settings menu.



Print Setting Menu 2

Paper Size		Card #1*, Card #2*, Card #3*, LTR, A4 For details on paper type, refer to the Bubble Jet Printer User Guide.
Borders	Borderless	Prints right to the edges of the page.
	Bordered	Prints with a border.

* Recommended paper size

1. In the print setting menu, turn the controller up to select [STYLE] and press the controller in.

Selecting the Paper Size

2. Make sure that  (Paper) is selected and press the controller in.
3. Press the controller up or down to select the paper size and press the controller in.

Pressing the MENU button brings you back to the print settings menu.



Selecting the Borders

2. Press the controller to the right or left to select **(Borders)** and press the controller in.
3. Press the controller to the right or left to select a **borders option** and press the controller in.

Pressing the MENU button brings you back to the print settings menu.



E

Print Setting Menu 3

Paper Settings

The setting options for paper size, paper type and borders vary depending on the printer. Refer to the instruction manual of the printer.

1. In the print setting menu, press the controller up to select **[PAPER]** and press the controller in.

Selecting the Paper Size

2. Make sure that **[PAPER SIZE]** is selected and press the controller in.
3. Press the controller to the right or left to select a **paper size** and press the controller in.

Pressing the MENU button brings you back to the print settings menu.



Selecting the Paper Type

4. Press the controller down to select **[PAPER TYPE]** and press the controller in.
5. Press the controller to the right or left to select a **paper type** and press the controller in.

Pressing the MENU button brings you back to the print settings menu.



Selecting the Borders

6. Press the controller down to select **[BORDERS]** and press the controller in.
7. Press the controller to the right or left to select a **borders option** and press the controller in.

Pressing the MENU button brings you back to the print settings menu.



Direct Printing

Including the Date in the Print

1. In the print setting menu, turn the controller up, down, to the right or left to select [☺] and press the controller in.
2. Turn the controller up or down to select [ON] and press the controller in.



Trimming Settings

Set the print style before you start with the trimming settings.

1. In the print setting menu, press the controller up or down to select [TRIMMING] and press the controller in.

The trimming frame appears.

2. Change the size of the trimming frame.

- Move the zoom lever toward **T** to shrink the frame, and toward **W** to enlarge the frame.
- To cancel the trimming settings, move the zoom lever toward **W** until the trimming frame disappears.

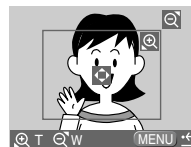

3. Move the trimming frame with the controller.

Pressing the MENU button brings you back to the print settings menu.



- About the color of the trimming frame (Canon Card Photo Printers only):
 - White: No trimming settings.
 - Green: Recommended trimming size. (The trimming frame may not appear in green depending on the image size, paper size or borders settings.)
 - Red: The image is magnified beyond recommended size. The image may print out coarsely.
- The trimming setting applies only to one image.
- The trimming setting is canceled with the following operations:
 - When you turn off the camcorder.
 - When you disconnect the interface cable.
 - When you expand the trimming frame beyond its maximum size.

Printing with Print Order Settings



E

You can print still images you have selected with the Print Order function. If you wish to print more than 1 copy, set the number of copies in the print order (□ 130).

When printing with print order settings, you can select the print style such as bordered or borderless, but not the trimming settings.



MENU

(□ 43)

➡ PRINT

1. Connect the printer to the camcorder (□ 144).
2. Press the MENU button.
3. Select [➡ PRINT].
 - The print setting menu appears.
 - "Set print order" appears, when you connect a printer with direct print function and select [➡ PRINT] without having set the print order.
 - The total number of prints set in the print order is displayed on the upper left of the screen.
4. Set the print style (□ 147).
5. In the print setting menu, press the controller up or down to select [OK] and press the controller in.

Printing starts. The print setting menu disappears when printing is complete.



- Cancel Printing
Press the controller in while "NOW PRINTING" is displayed. A confirmation dialog appears. Select [OK] and press the controller in. Printing stops even if it is incomplete and the paper is fed through.
- Restarting Printing (with print order only)
Open the CARD PLAY (VCR) menu and select [➡ PRINT]. Select [RESTART] in the print setting menu and press the controller in. The remaining images will be printed.
Printing cannot be restarted in the following cases:
 - When you change the print order settings.
 - When you delete a still image with print order settings.
- If an error message appears, see *Printing Errors* (□ 146) and *Direct Print Related Messages* (□ 159).

About the NETWORK Mode

E

The NETWORK mode is for use with DV Messenger version 2 (Windows XP only).

Set the camcorder to NETWORK mode and connect it to the computer using a USB cable or DV (IEEE1394) cable.

For details on DV Messenger version 2, refer to the DV Network Software Instruction Manual.



Do not connect the camcorder to a printer when the camcorder is set to NETWORK mode.

Connection

First, install DV Messenger. If you wish to connect the camcorder using a USB cable, you also need to install the Canon USB Video Driver.

1. Connect the power adapter to the camcorder.
2. Press the small button below the POWER switch and turn the POWER switch to NETWORK.
3. Connect the camcorder to the computer using a USB cable or DV cable.
 - "NETWORK MODE" appears on the camcorder screen.

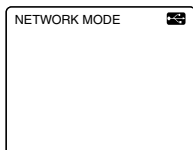

USB Connection

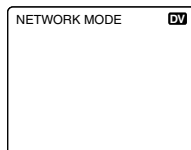

DV Connection

- When you have connected the camcorder to the computer, start DV Messenger. You can now operate the camcorder from the computer using DV Messenger.



- When DV Messenger is started and set up for communication, the video picture appears on the computer screen.
- In NETWORK mode, the camcorder can only be operated from the computer, except for the following functions:
 - When the DV Messenger [CAMERA] control panel is displayed: Zoom and focus (when DV Messenger set to autofocus)
 - When the DV Messenger [VCR] control panel is displayed: Volume adjustment of the built-in speaker
- Following functions cannot be used with DV Messenger:
 - Image stabilizer
 - Built-in flash
- The camcorder cannot be operated with the wireless controller.

Screen Displays



LCD Screen Displays

You can hide the displays on the LCD screen to have a clear screen for playback.



Open the menu and select [DISPLAY SET UP]. Select [DISPLAYS], set it to [OFF <PLAYBK>] and close the menu.

- The LCD screen will become completely blank (also the TV screen if connected).
- Warning messages still appear, and the data code appears if turned on.
- Tape operation displays appear for 2 seconds.
- Displays cannot be hidden on the index screen.

TV Screen Displays

When you connect a TV for recording/playback, you can hide the displays on the TV screen. For connecting instructions, see *Playing Back on a TV Screen* (40).



Press the TV SCREEN button on the wireless controller.

- When the POWER switch is set to CAMERA: The displays disappear from the TV screen and appear when you press the button again.
- When the POWER switch is set to PLAY (VCR): The displays appear on the connected TV screen and disappear when you press the button again. The setting resets to the OFF setting when you turn the camcorder off.

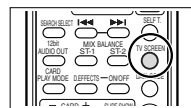

When the TV screen displays are hidden, the displays still appear on the LCD screen. If you turn on the data code, displays other than the data code will disappear from the LCD screen.

You can also change the setting in the menu during recording:



Open the menu and select [DISPLAY SET UP]. Select [TV SCREEN], set it to [OFF] and close the menu.

E

Screen Displays during Basic Recording/Playback

 indicates flashing.

E

CAMERA mode (battery pack attached):



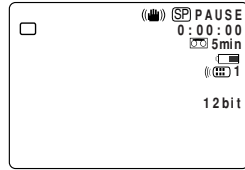





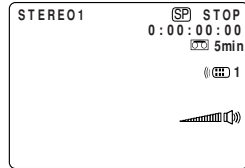







- Remote sensor mode and audio mode disappear after a few seconds.



PLAY (VCR) mode:

- Remote sensor mode and volume bar disappear after a few seconds.



REC		: Fast forward playback/rewind playback (□38)
PAUSE		: Pause (□38)
STOP		: Stop (□38)
EJECT		: Eject (□38)
		: x2 playback (forward and reverse) (□38)
		: x1 playback (forward and reverse) (□38)
		: Slow playback (forward and reverse) (□38)
		: Frame advance playback/frame reverse playback (□38)
		: Playback pause (forward and reverse) (□38)
		: Date search/photo search (□94)

RTN  RTN : Zero set memory (forward and reverse) (□95)
 : AV insert editing (□103)
 : Audio dubbing (□105)

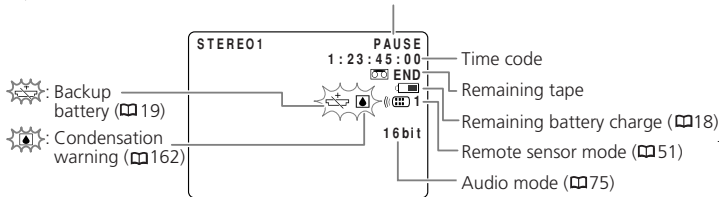

Screen Displays during Advanced Recording/Playback

CAMERA Mode

E

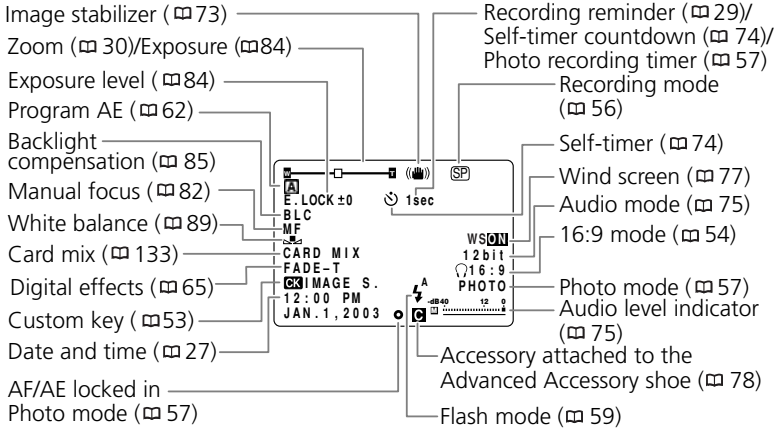

PLAY (VCR) Mode

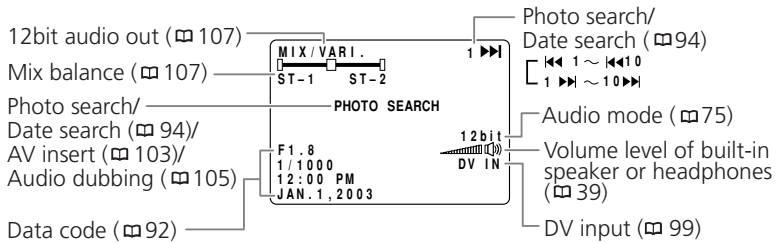

CARD CAMERA Mode

E

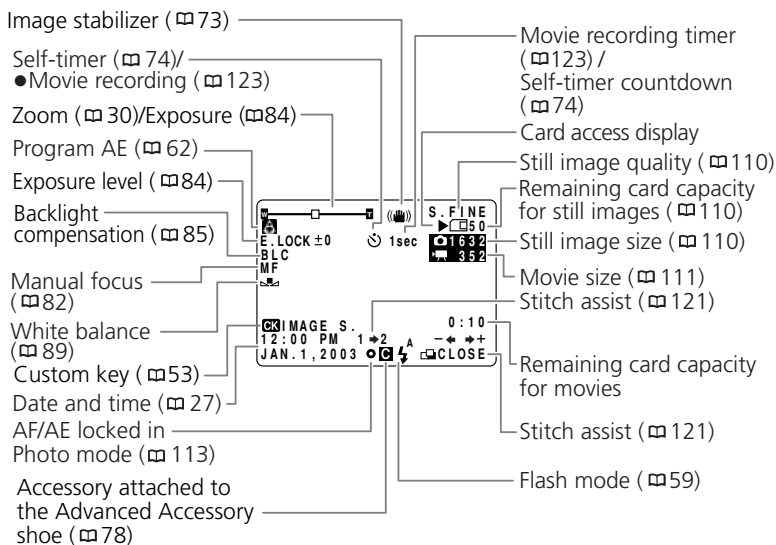

CARD PLAY (VCR) Mode

Still image playback mode

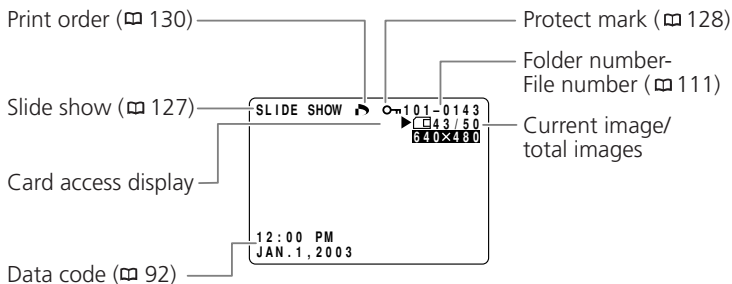

Movie playback mode

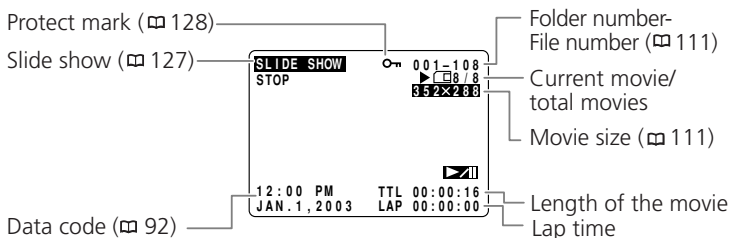



List of Messages

Message	Explanation	
SET THE TIME ZONE, DATE AND TIME	You have not set the time zone, date and time. This message appears each time you turn the power on until you set the time zone, date and time.	25
CHANGE THE BATTERY PACK	Battery pack is exhausted. Replace or charge the battery pack.	16
THE TAPE IS SET FOR ERASURE PREVENTION	Cassette is protected. Replace the cassette or change the position of the protect switch.	23
REMOVE THE CASSETTE	Camcorder stopped operating to protect the tape. Unload and reload the cassette.	22
CHECK THE DV INPUT	DV cable is not connected, or the connected digital device is turned off.	99
CONDENSATION HAS BEEN DETECTED	Condensation has been detected in the camcorder.	162
TAPE END	Tape reached the end. Rewind the tape or replace the cassette.	37
CHECK THE CASSETTE [REC MODE]	You attempted to perform audio dubbing or AV insert on a tape recorded in a mode other than the SP mode.	56
CHECK THE CASSETTE [AUDIO MODE]	You attempted to perform audio dubbing on a tape recorded in 16-bit or 12-bit 4-channel sound.	105
CHECK THE CASSETTE [BLANK]	You attempted to perform audio dubbing or AV insert on a tape with a blank section.	103
HEADS DIRTY, USE CLEANING CASSETTE	Video heads are dirty. Clean the video heads.	161
COPYRIGHT PROTECTED PLAYBACK IS RESTRICTED	You attempted to play back a copyright protected tape.	100
COPYRIGHT PROTECTED DUBBING RESTRICTED	You attempted to dub a copyright protected tape. May also appear when an anomalous signal is received during analog line-in recording, or during analog-digital conversion of a copyright protected tape.	100

E

Memory Card Related Messages

E

Message	Explanation	
NO CARD	Memory card not inserted into the camcorder.	109
THE CARD IS SET FOR ERASURE PREVENTION	SD Memory Card is set for erasure prevention. Replace the card or change the position of the protect switch.	109
NO IMAGES	No images are recorded on the memory card.	125
CARD ERROR	A memory card error occurred. The camcorder cannot record or play back the image. The error may be temporary. If the message disappears after 4 seconds and  flashes red, turn the camcorder off, remove the card and reinsert the card. If  changes to green, you can continue recording/playback.	109
CARD FULL	No remaining capacity on the memory card. Replace with another card or erase images.	129
NAMING ERROR	File or folder number has reached the maximum value.	111
UNIDENTIFIABLE IMAGE	Image is recorded in a not compatible JPEG format or another format not compatible with the camcorder, or the image file is corrupted.	125
 PRINT ORDER ERROR	You attempted to set more than 200 still images in the print order.	130
THIS IMAGE CANNOT BE RECORDED	Some analog images cannot be recorded on the memory card depending on the signal.	116
THE MEMORY CARD COVER IS OPEN	The cover of the memory card compartment is open. Close the cover.	109

Direct Print Related Messages

Message	Explanation
Paper error	There is a problem with the paper.
No Paper	Paper is not correctly inserted or there is no paper.
Paper Jam	The paper jammed during printing.
Paper has been changed	Paper size has been changed between print setting and start of printing.
Incompatible paper size	You attempted to print on paper that cannot be used with the camcorder.
Media type error	You attempted to use a paper size/type that is not supported by the printer.
Ink error	There is a problem with the ink cassette.
Ink Cassette Error	There is a problem with the ink cassette.
No Ink	The ink cartridge is not inserted or is out of ink.
Paper and ink do not match	The ink cannot be used with the selected paper type.
Low ink level	The ink cartridge needs to be replaced soon.
Waste tank full	Waste tank is full. Refer to the instruction manual of your printer.
File error	You attempted to print an image that was made with another camcorder, has a different format, or was edited on a computer.
Cannot Print!	You attempted to print an image that was made with another camcorder, has a different format, or was edited on a computer.
Could not print X images	You attempted to use the print order settings to print X images that were made with another camcorder, have a different format or were edited on a computer.
Set print order	You attempted to print an image from the CARD PLAY (VCR) menu [▶▶ PRINT] without having set the print order.
Cannot trim	You attempted to trim an image with an image size of 160 × 120, or an image not recorded in the 4:3 ratio.
Readjust trimming	You changed the print style after you set the trimming settings.
Printer error	Turn off the printer and turn it back on.
Recharge the printer battery	The printer battery is depleted.
Communication Error	The printer is experiencing a data transmission error.
Printer in use	The printer is in use. Check the printer status.
Printer warming up	Printer is warming up. If the message does not disappear after a few seconds, check the printer status.
Paper lever error	Paper lever error occurred. Adjust the paper selection lever to the proper position.
Printer cover open	Close the printer cover securely.
No printhead	No print head is installed in the printer.

E

Maintenance

E

Camcorder Handling Precautions

- Do not carry the camcorder by the LCD panel or viewfinder.
- Do not leave the camcorder in places subject to high temperatures, such as a sun-heated car, and high humidity.
- Do not use the camcorder in places subject to magnetic or electric fields such as near the TV transmitters or portable communication devices.
- Do not point the lens or viewfinder at strong light sources. Do not leave the camcorder pointed at a bright subject.
- Do not use the camcorder in dusty or sandy places. Dust or sand getting inside the cassette or camcorder may cause damage. Dust and sand can also damage the lens. Attach the lens cap after use.
- The camcorder is not waterproof. Water, mud or salt getting inside the cassette or camcorder may cause damage.
- Be careful of heat generated by lighting equipment.
- Do not disassemble the camcorder. If the camcorder does not function properly, consult qualified service personnel.
- Handle the camcorder with care. Do not subject the camcorder to shocks or vibration as this may cause damage.
- Avoid sudden changes in temperature. Moving the camcorder rapidly between hot and cold temperatures may cause condensation to form on its internal surfaces (📖 162).

Storage

- If you do not intend to use the camcorder for a long time, store it in a place free of dust, in low humidity, and at temperatures not higher than 86°F (30°C).
- After storage, check the functions of your camcorder to make sure that the camcorder is still working properly.

Cleaning

Camcorder Body and Lens

- Use a soft, dry cloth to clean the camcorder body and lens. Never use chemically treated cloth or volatile solvents such as paint thinner.

LCD Screen

- Clean the LCD screen using a commercially available cleaning cloth for glasses.
- Condensation may form on the surface of the screen when the temperature changes suddenly. Wipe it with a soft dry cloth.

- At cold temperatures, the screen may be darker than usual. This is not a malfunction. The screen returns to normal when the camcorder warms up.

Viewfinder

- Extend the viewfinder and move it upward. Remove the protect cover and clean the glass with a cotton swab. Reattach the protect cover when finished.
- Be careful not to scratch the glass when cleaning.

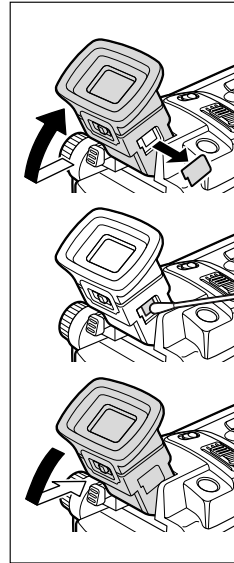

E

Video Heads

- When the message "HEADS DIRTY, USE CLEANING CASSETTE" appears, or when the playback picture becomes distorted, the video heads need to be cleaned.
- To maintain the best picture quality, we recommend cleaning the video heads frequently with the Canon DVM-CL Digital Video Head Cleaning Cassette or a commercially available dry cleaning cassette.
- Do not use wet type cleaning cassettes as this may damage the camcorder.



Condensation

E

Moving the camcorder rapidly between hot and cold temperature may cause condensation (water droplets) to form on its internal surfaces. Stop using the camcorder if condensation is detected. Continued use may damage the camcorder.

Condensation may form in the following cases:

When the camcorder is moved from an air-conditioned room to a warm, humid place

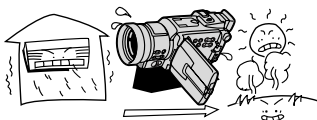

When the camcorder is moved from a cold place to a warm room

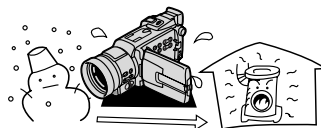

When the camcorder is left in a humid room

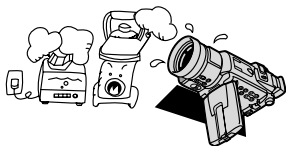



When a cold room is heated rapidly



How to avoid condensation:

- Unload the cassette, place the camcorder in an airtight plastic bag and let it adjust to temperature changes slowly before removing it from the bag.

When condensation is detected:

- The camcorder stops operating and the warning message "CONDENSATION HAS BEEN DETECTED" appears for approx. 4 seconds and  starts flashing.
- If a cassette is loaded, the warning message "REMOVE THE CASSETTE" appears and  starts flashing. Remove the cassette immediately and leave the cassette compartment open. Leaving the cassette in the camcorder may damage the tape.
- A cassette cannot be loaded when condensation is detected.

Resuming use:

- It takes about 1 hour until the water droplets evaporate. After the condensation warning stops flashing, wait for 1 more hour before resuming use.

Using the Camcorder Abroad

Power Sources

You can use the compact power adapter to operate the camcorder and to charge battery packs in any country with power supply between 100 and 240 V AC, 50/60 Hz. Consult the Canon Service Center for information on plug adapters for overseas use.

E

Playback on a TV Screen

You can only play back your recordings on TVs with NTSC system. The NTSC system is used in the following countries/areas:

American Samoa, Antigua, Aruba, Bahamas, Barbados, Bermuda, Bolivia, Canada, Chile, Columbia, Costa Rica, Cuba, Ecuador, El Salvador, Guam, Guatemala, Greenland, Haiti, Honduras, Jamaica, Japan, Korea, Mexico, Micronesia, Myanmar, Nicaragua, Panama, Peru, Philippines, Puerto Rico, Saint Kitts and Nevis, Saint Lucia, Saint Vincent and the Grenadines, Surinam, Taiwan, Trinidad and Tobago, USA, Venezuela, Virgin Islands.

Troubleshooting



E

If you have a problem with your camcorder, refer to this checklist. Consult your dealer or a Canon Service Center if the problem persists.

Power Source

Problem	Cause	Solution	
Camcorder will not turn on.	Battery pack is exhausted.	Replace or charge the battery pack.	16
	Battery pack is not correctly attached.	Attach the battery pack correctly.	16
The camcorder switches off by itself.	Battery pack is exhausted.	Replace or charge the battery pack.	16
	Power save function has been activated.	Turn on the camcorder.	28
Cassette compartment will not open.	Battery pack is exhausted.	Replace or charge the battery pack.	16
	Cassette compartment cover is not fully open.	Open the cassette compartment cover fully.	22
Cassette compartment stopped during loading/unloading.	Battery pack is exhausted.	Replace or charge the battery pack.	16
	The camcorder malfunctions.	Consult a Canon Service Center.	-
LCD/viewfinder switches on and off.	Battery pack is exhausted.	Replace or charge the battery pack.	16

Recording/Playback

Buttons will not work.	Camcorder is not turned on.	Turn on the camcorder.	28
	Cassette is not loaded.	Load a cassette.	22
 flashes on the screen.	Battery pack is exhausted.	Replace or charge the battery pack.	16
 flashes on the screen.	Condensation is detected.	See reference page.	162
"Remove the cassette" appears on the screen.	Camcorder stopped operating to protect the tape.	Unload and reload the cassette.	22
The wireless controller will not work.	Camcorder and wireless controller are not set to the same remote sensor mode.	Change the remote sensor modes.	51
	Batteries of the wireless controller are exhausted.	Replace the batteries.	24
 flashes red on the screen.	The camcorder malfunctions.	Consult a Canon Service Center.	-

Recording

Problem	Cause	Solution	
Image will not appear on the screen.	Camcorder is not set to CAMERA mode.	Set the camcorder to CAMERA mode.	28
“Set the time zone, date and time” appears on the screen.	Time zone, date and time are not set, or the backup battery is exhausted.	Set the time zone, date and time, or replace the backup battery and reset the date and time.	25
Pressing the start/stop button will not start recording.	Camcorder is turned off.	Turn on the power.	28
	Cassette is not loaded.	Load a cassette.	22
	Tape reached the end (END flashes on the screen).	Rewind the tape or replace the cassette.	22
	Cassette is protected (P flashes on the screen).	Replace the tape or change the position of the protect switch.	23
	Camcorder is set to a mode other than the CAMERA mode.	Set the camcorder to CAMERA mode.	28
Camcorder will not focus.	Autofocus does not work on that subject.	Focus manually.	82
	Viewfinder is not adjusted.	Adjust the viewfinder with the diopter adjustment lever.	20
	Lens is dirty.	Clean the lens.	160
A vertical light bar appears on the screen.	Bright light in a dark scene may cause a vertical light bar (smear) to appear. This is not a malfunction.	---	-
Sound is distorted or recorded in a lower volume than the actual volume.	When recording near loud sound (such as fireworks, drums or concerts), sound may become distorted or may not be recorded in the actual sound level. This is not a malfunction.	---	-
Viewfinder picture is blurred.	Viewfinder is not adjusted.	Adjust the viewfinder with the diopter adjustment lever.	20

Playback

Pressing the playback button does not start playback.	Camcorder is turned off, or is not set to PLAY (VCR) mode.	Set the camcorder to PLAY (VCR) mode.	37
	Cassette is not loaded.	Load a cassette.	22
	Tape reached the end (END flashes on the screen).	Rewind the tape.	37
Image will not appear on the TV screen.	[AV → DV OUT] is set to [ON].	Set [AV → DV OUT] to [OFF].	101
Tape is running, but image will not appear on the TV screen.	TV/VIDEO selector on the TV is not set to VIDEO.	Set the selector to VIDEO.	40
	Video heads are dirty.	Clean the video heads.	161
	You attempted to play back or dub copyright protected tape.	Stop playback/dubbing.	100
No sound from the built-in speaker.	Speaker volume is turned off.	Adjust the volume with the selector dial.	39

Memory Card Operation

Problem	Cause	Solution	
Memory card cannot be inserted.	Memory card was not facing the correct direction.	Turn the memory card over and reinsert it.	108
Memory card cannot be recorded.	Memory card is full.	Replace the memory card or erase images.	128
	Memory card is not formatted.	Format the memory card.	137
	Memory card is not inserted.	Insert a memory card.	108
	File number reached maximum value.	Set [FILE NUMBERS] to [RESET] and insert a new memory card.	110
	SD Memory Card is protected.	Change the position of the protect switch.	108
	Memory card cannot be played back.	Camcorder is not set to CARD PLAY (VCR) mode.	Set the camcorder to CARD PLAY (VCR) mode.
Memory card is not inserted.		Insert a memory card.	108
Camcorder does not display movies in CARD PLAY (VCR) mode.	The camcorder displays the still image playback mode.	Press the CARD STILL/MOVIE button to switch to MPEG4 movie playback.	125
	The movie was recorded in Motion JPEG format with another camcorder.	Motion JPEG movies are displayed in still image playback mode. Press the CARD STILL/MOVIE button to switch to still image playback.	125
Image cannot be erased.	Image is protected.	Cancel the protection.	127
	SD memory card is protected.	Change the position of the protect switch.	108
 flashes red.	Card error occurred.	Turn off the camcorder. Remove and reinsert the memory card. Format the memory card if flashing persists.	137

Printing

The printer is not operating even though camcorder and printer are correctly connected.	The camcorder is set to NETWORK mode.	<ol style="list-style-type: none"> 1. Set the camcorder to CARD PLAY (VCR) mode. 2. Disconnect and reconnect the USB cable. 3. Turn off the printer and turn it back on. 	—
-----------------------------------------------------------------------------------------	---------------------------------------	-----------------------------------------------------------------------------------------------------------------------------------------------------------------------------------------------------------	---

System Diagram (Availability differs from area to area)

E

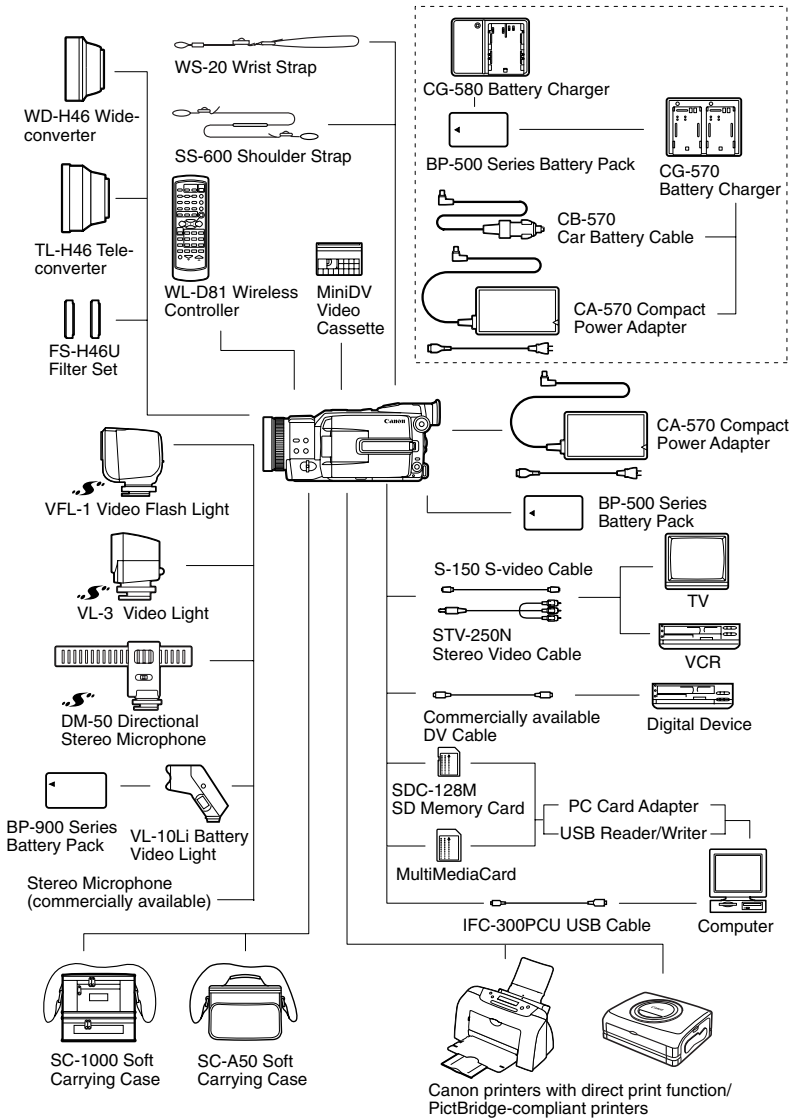

Additional Information

Optional Accessories

E

Call or visit your local retailer/dealer for genuine Canon video accessories. You can also obtain genuine accessories for your Canon camcorder by calling: 1-800-828-4040, Canon U.S.A. Information Center.

Use of genuine Canon accessories is recommended.

This product is designed to perform optimally when used with genuine Canon accessories. Canon shall not be liable for any damage to this product and/or accidents such as fire, etc., caused by the malfunction of non-genuine Canon accessories (e.g., a leakage and/or explosion of a battery pack). Please note that this warranty does not apply to repairs arising out of the malfunction of non-genuine Canon accessories, although you may request such repairs on a chargeable basis.

BP-500 Series Battery Packs

When you need extra battery packs, select from the following: BP-511, BP-512, BP-522 or BP-535.

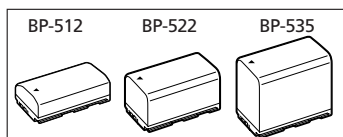

CG-580 Battery Charger

Use the battery charger for charging BP-500 series battery packs. It plugs directly into a power outlet without a cable.

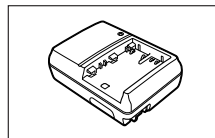

CG-570 Battery Charger

The battery charger can be used with the supplied CA-570 Compact Power Adapter or the optional CB-570 Car Battery Cable to charge BP-500 series battery packs.

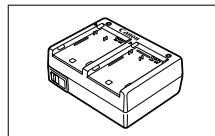

Battery Pack	Charging Time*	
	CG-580	CG-570
BP-512 (supplied)	80 min.	95 min.
BP-511 (Optional)	80 min.	95 min.
BP-522 (Optional)	150 min.	140 min.
BP-535 (Optional)	210 min.	205 min.

* Charging time varies according to the charging condition.

CB-570 Car Battery Cable

Use the car battery cable with the CG-570 Battery Charger to charge battery packs on the move. The car battery cable plugs into your car's cigarette lighter and runs off a 12-24 V DC negative ground battery.

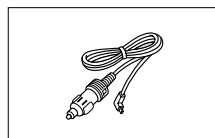

TL-H46 Tele-converter

This Tele-converter lens increases the focal length of the camcorder lens by a factor of 1.7.

- The image stabilizer is not as effective when the Tele-converter is attached.
- The image quality may be degraded at the telephoto side.
- The minimum focusing distance with the Tele-converter is 9.8 ft (3 m); 2.4 in. (6 cm) at maximum wide angle (7.1 in. (18 cm) in CARD CAMERA mode).
- When using the assist lamp or the VFL-1 Video Flash Light with the Tele-converter attached, the shadow of the Tele-converter may appear on the picture.

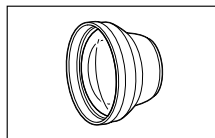

E

WD-H46 Wide-converter

This lens decreases focal length by a factor of 0.7, giving you a wide perspective for indoor shots or panoramic views.

- When using the assist lamp or the VFL-1 Video Flash Light with the Wide-converter attached, the shadow of the Wide-converter may appear on the picture.

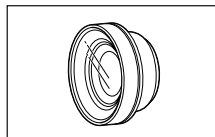

FS-H46U Filter Set

Neutral density and MC protector filters help you to control difficult lighting conditions.

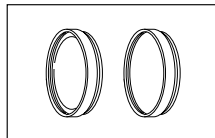

VL-10Li Battery Video Light

This compact yet powerful video light can be used for both indoor and outdoor shooting. It attaches to the camcorder's accessory shoe and is powered by BP-900 series battery packs.

- Approximate usage time: BP-915: 60 min., BP-930: 120 min., BP-945: 170 min.
- BP-900 series battery packs are charged with the CA-920 Compact Power Adapter or CH-910 Dual Battery Charger/Holder.

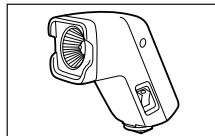

VFL-1 Video Flash Light

This video flash light allows you to record still images and movies even at night or in dark places. It attaches to the camcorder's advanced accessory shoe for cable-free operation.

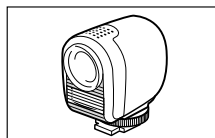

VL-3 Video Light

This video light enables you to record brightly in color even in dark places. It attaches to the camcorder's advanced accessory shoe for cable-free operation.

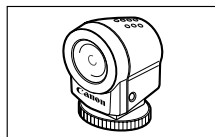

DM-50 Directional Stereo Microphone

This highly sensitive, super-directional microphone attaches to the camcorder's advanced accessory shoe. It can be used as directional microphone (monaural) or stereo microphone.

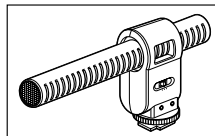

WS-20 Wrist Strap

Use this for extra additional protection for active shooting.

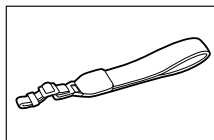

E

SC-1000 Soft Carrying Case

A handy camcorder bag with padded compartments and plenty of space for accessories.



SC-A50 Soft Carrying Case

This lightweight bag keeps the camcorder within easy reach without weighing you down or getting in the way.



This mark identifies genuine Canon video accessories. When you use Canon video equipment, we recommend Canon-brand accessories or products bearing the same mark.



Provided Accessories:

WL-D81 Wireless Controller	D83-0662-000
SS-600 Shoulder Strap	3122A002AA (D81-1330-201)
Lens Hood	D52-0250-000
Lens Cap	D52-0240-000
CA-570 Compact Power Adapter	9468A002AA
BP-512 Battery Pack	6760A002AA
STV-250N Stereo Video Cable	3067A002AA (D82-0590-201)
S-Video Cable	3062A002AA (D82-0330-000)
IFC-300PCU USB Cable	6906A001AA

Optional Accessories:

BP-511 Battery Pack	3055A002AA (D85-1112-201)
BP-522 Battery Pack	3174A002AA (D85-1122-201)
BP-535 Battery Pack	6741A002AA
SC-1000 Soft Carrying Case	3083A002AA (D81-1200-201)
SC-A50 Soft Carrying Case	D81-1302-201
WD-H46 Wide-converter	9032A001AA
TL-H46 Tele-converter	9033A001AA
FS-H46U Filter Set	9034A001AA
DM-50 Directional Stereo Microphone	3176A002AA (D84-0120-201)
VFL-1 Video Flash Light	8834A001AA
VL-3 Video Light	3175A002AA (D86-0121-201)
VL-10Li Battery Video Light	3140A002AA (D86-0081-201)
JR 7.2V 10WF Halogen Bulb	3141A002AA (D86-0090-201)
WS-20 Wrist Strap	3118A002AA (D81-0190-202)
DVM-CL DV Cleaning Cassette	3134A002AA (D36-0032-201)

Specifications

OPTURA Xi

E

Power supply (rated):	7.4 V DC
Power consumption (AF turned on):	4.5 W (using viewfinder), 5.7 W (using LCD screen)
Television system:	EIA standard (525 lines, 60 fields) NTSC color signal
Video recording system:	2 rotary heads, helical scanning DV system (Consumer digital VCR SD system); Digital component recording
Audio recording system:	Tape: PCM digital sound: 16 bit (48 kHz/2 ch); 12 bit (32 kHz/4 ch) Card: ADPCM digital sound: 16 bit (8 kHz/1 ch), 4 bit
Image sensor:	1/3.4" CCD (charge coupled device), approx. 2,200,000 pixels (Effective pixels: tape: approx. 1,230,000 pixels, card: approx. 2,000,000 pixels)
Tape format:	Videocassettes bearing the "MiniDV" mark.
Tape speed:	SP: 0.74 ips (18.81 mm/s), LP: 0.49 ips (12.56 mm/s)
Maximum recording time (80 min. cassette):	SP: 80 min., LP: 120 min.
Fast forward/rewind time:	Approx. 2 min. 20 sec. (with a 60 min. cassette)
Lens:	F1.6-1.9, 11x power zoom, f=4.2-47 mm; (16:9 mode: F1.6-1.9, 10x power zoom, f=4.7-47 mm; card: F1.8-2.8, 9x power zoom, f=5.2-47 mm)
Focusing system:	TTL autofocus, manual focusing possible
Minimum focusing distance:	3.3 ft. (1 m); 0.79 in. (2 cm) on maximum wide angle (card: 2.4 in. (6 cm))
Maximum shutter speed:	1/2,000 sec. (1/500 sec. when using a memory card)
Minimum illumination:	1.3 lx (using the Night mode)
Recommended illumination:	More than 100 lx
Filter diameter:	46 mm
Viewfinder:	0.33 in., TFT color LCD, approx. 113,000 pixels
LCD screen:	3.5 in., TFT Color, approx. 246,000 pixels
Microphone:	Stereo electret condenser microphone
Recording media:	SD Memory Card, MultiMediaCard
Number of recording pixels:	Still image: 1632 × 1224, 1280 × 960, 640 × 480 pixels Movie: 352 × 288 pixels, 176 × 144 pixels, 15 frames/sec.
Estimated SD Memory Card SD-C8M capacities:	1632 × 1224: Superfine: 3 images/Fine: 5 images/Normal: 10 images; 1280 × 960: Superfine: 5 images/Fine: 9 images/Normal: 16 images; 640 × 480: Superfine: 34 images/Fine 50 images/Normal: 84 images
The actual number varies according to the images. Sample images recorded on the supplied SD Memory Card are to be included in the total number.	
Maximum continuous shots:	1632 × 1224: Flash on/off: 10 images (2 frames/sec.) 1280 × 960: Flash on: 10 images (2 frames/sec.); Flash off: 10 images (3 frames/sec.) 640 × 480: Flash on: 30 images (2 frames/sec.); Flash off: 30 images (3 frames/sec.)
File format:	Design rule for Camera File system (DCF), Exif 2.2 compliant, Digital Print Order Format (DPOF) compliant (still images only)
This camcorder supports Exif 2.2 (also called "Exif Print"). Exif Print is a standard for enhancing the communication between camcorders and printers. By connecting to an Exif Print-compliant printer, the camcorder's image data at the time of shooting is used and optimized, yielding extremely high quality prints.	

Image format:	Still image: JPEG (Compression mode: Superfine, Fine, Normal), Movie: MPEG-4
USB terminal:	mini-B
DV terminal input/output:	Special 4-pin connector (IEEE 1394 compliant)
AV terminal input/output:	ø3.5 mm minijack Audio input: -10 dBV/40 kohms or more Audio output: -10 dBV (47 kohm load)/3 kohms or less Video: 1 Vp-p/75 ohms unbalanced
S-video terminal input/output:	1 Vp-p/75 ohms (Y signal), 0.286 Vp-p/75 ohms (C signal)
MIC terminal input:	ø3.5 mm stereo mini-jack -37 dBV (with 600 ohm mic)/5 kohms or more (MIC ATT ON) -57 dBV (with 600 ohm mic)/5 kohms or more (MIC ATT OFF)
Headphone terminal:	ø3.5 mm stereo minijack
Operating temperatures:	32 – 104°F (0 – 40°C)
Dimensions:	3.2 × 3.5 × 7.9 in. (80 × 90 × 201 mm)
Weight:	1.6 lb. (725 g)

CA-570 Compact Power Adapter

Power supply:	100 – 240 V AC, 50/60 Hz
Power consumption:	17W
Rated output:	8.4 V DC, 1.5 A
Operating temperature:	32 – 104°F (0 – 40°C)
Dimensions:	2.1 × 3.5 × 1.1 in. (52 × 90 × 29 mm)
Weight:	4.8 oz. (135 g)

BP-512 Battery Pack

Battery type:	Rechargeable Lithium Ion Battery
Rated voltage:	7.4 V DC
Operating temperature:	32 – 104°F (0 – 40°C)
Battery capacity:	1100 mAh
Dimensions:	1.5 × 0.83 × 2.2 in. (38 × 21 × 55 mm)
Weight:	2.5 oz. (70g)

SDC-8M SD Memory Card

Capacity:	8 MB
Interface:	SD Memory Card standard
Operating temperature:	32 – 104°F (0 – 40°C)
Dimensions:	1.3 × 0.94 × 0.08 in. (32 × 24 × 2.1 mm)
Weight:	0.07 oz. (2 g)

Weight and dimensions are approximate. Errors and omissions excepted. Subject to change without notice.

Index

112bit audio 107
16:9 wide screen 54
6-second auto date 93

A

Abroad, using the camcorder . . . 163
Accessories 9, 168
Advanced accessory shoe . . 21, 78-81
AF assist lamp 60
Analog line-in 98
Analog-digital converter 101
Aperture 88
Aperture-Priority (Av) mode . . 63, 88
Assist lamp 64
Audio dubbing 105
Audio level 75
Audio mode 75
Auto 62
Auto Exposure Bracketing 120
Autofocus 82
AV insert 103
AV terminal 40
AV→DV 101

B

Backlight compensation 85
Backup battery 19
Battery charger 168
Battery pack 16, 168
Beep 54
Brightness 33
Built-in flash 59

C

Card mix 133
Computer 108, 139
Condensation 162
Connections - TV 40
Connections - VCR 40
Continuous shooting 119
Copyright signals 100
Copying still images 136
Custom key 53

D

Data code 92

Date and time 25
Date search 94
Demo mode 55
Digital effects 65
Digital zoom 30
Direct print function 144
Drive mode 119
DV dubbing 99
DV terminal 97, 108

E

Easy recording 62
Effects 69
Erasing still images 129
Exposure 84

F

Faders 66
Fast forward 37
File numbers 111
Focusing 82
Focusing point 117
Focus-Priority 118
Formatting 138

G

Grip belt 21

H

Headphones 39, 77

I

Image quality 110
Image stabilizer 73
Index screen 126

L

LCD mirror mode 33
LCD screen 32
Lens cap 20
LP mode 56

M

Magnifying the image 91
Maintenance 160
Manual focus 82

E

**Additional
Information**

Memory card 109, 141
 Menus 43
 Microphone 76, 81
 Microphone attenuator 76
 MIC terminal 76
 Movie playback mode 126
 Movie size 111
 MultiMediaCard *2 109, 141
 Multi-image screen 71
 My Camera settings 52

N

NETWORK mode 152
 Night mode 63

O

Operating mode 8
 Output channel 42

P

Photo search 94
 Playback - Memory card 125
 Playback - Tape 37
 Playback pause 38
 Power adapter 15, 16
 Print order 130, 151
 Program AE 62
 Protect 128

R

Record pause mode 28
 Record review 35
 Record search 35
 Recording Movies
 (memory card) 123
 Recording Movies (tape) 28
 Recording programs 62
 Recording Still Images
 (memory card) 113
 Recording Still Images (tape) 57
 Recording to a VCR 96
 Remote sensor 51
 Rewind 37

S

S1 video terminal 40
 Sample images 142
 Sand & Snow mode 63
 Screen displays 153

SD Memory Card 109, 141
 Search select 94
 Self-timer 74
 Shutter-Priority (Tv) mode 63, 86
 Shutter sound 52
 Shutter speed 86
 Slide show 127
 SP mode 56
 Speaker 39
 Spotlight mode 63
 Still image playback mode 125
 Still image quality 110
 Still image size 110
 Stitch Assist mode 121
 Super Night mode 64

T

Tally lamp 54
 Tape protection 23
 Telephoto 30
 Time code 154
 Time zone 25
 Tripod 36
 Troubleshooting 164
 TV Screen 40, 153

U

USB terminal 139

V

Video heads 161
 Video ID-1 system 40
 Video light 78, 79
 Videocassettes 22
 Viewfinder 20, 161

W

White balance 89
 Wide screen 54
 Wind screen 77
 Wireless controller 14, 24, 51

Z

Zebra Pattern 85
 Zero set memory 95
 Zooming 30

U.S.A.

CANON® OPTURA Xi DIGITAL VIDEO CAMCORDER LIMITED WARRANTY

E

The limited warranty set forth below is given by Canon U.S.A., Inc. ("CUSA") with respect to each Canon OPTURA Xi Digital Video Camcorder ("DV Camcorder") purchased and used in the United States.

Each Canon DV Camcorder, when delivered to you in new condition in its original container, is warranted against defective material or workmanship as follows: for a period of one (1) year from the date of original purchase (three (3) months in the case of the video head part), defective parts or DV Camcorders returned to a CUSA factory service center ("CUSA Center") or an authorized DV Camcorder service facility ("Service Facility"), and proven to be defective upon inspection, will be repaired or exchanged for new or comparable rebuilt parts or DV Camcorders. The warranty period for repaired or replacement parts or DV Camcorders shall begin upon shipment of the same, but shall in no event exceed the original warranty period of the defective part or DV Camcorder.

Non-Canon brand peripheral equipment and software which may be distributed with Canon DV Camcorders are sold "AS IS", without warranty of any kind by CUSA, including any implied warranty regarding merchantability or fitness for a particular purpose. The sole warranty with respect to such non-Canon brand items is given by the manufacturer or producer thereof.

CUSA shall have no responsibility under this limited warranty for use of Canon DV Camcorders in conjunction with incompatible peripheral equipment and incompatible software.

In order to obtain warranty service, contact the authorized Canon retail dealer from whom you purchased the DV Camcorder or call the CANON INFORMATION CENTER AT 1-800-828-4040 (which is open from 9:00 a.m. to 5:00 p.m. (E.S.T.), Monday through Friday, excluding holidays). Have your unit serial number and your date of purchase available when you make the call to expedite service. In either case you will be directed to ship the DV Camcorder, postage prepaid, to the CUSA Center or Service Facility nearest to you. You must include a copy of the proof of purchase (bill of sale) and a complete explanation of the problem. DV Camcorders covered by this limited warranty will be repaired and returned to you without charge by the CUSA Center or the Service Facility. Repairs not under warranty will be at such cost as the CUSA Center or Service Facility may from time to time generally establish.

This limited warranty covers all defects encountered in normal use of the DV Camcorder, and does not apply in the following cases:

- (a) Loss of or damage to the DV Camcorder due to abuse, mishandling, improper packaging by you, alteration, accident, leaking batteries, exterior nicks, scratches or dents, electrical current fluctuations, failure to follow operating instructions, maintenance and environmental instructions prescribed in CUSA's instruction manual, or service performed by other than a CUSA Center or Service Facility.
- (b) Use of parts or supplies (other than those sold by CUSA) which cause damage to the DV Camcorder or cause abnormally frequent service calls or service problems.
- (c) If any DV Camcorder has had its serial number or dating altered or removed.

This limited warranty does not apply to accessories or consumables for the DV Camcorder, which are sold "AS IS", without warranty of any kind by CUSA.

NO IMPLIED WARRANTY, INCLUDING ANY IMPLIED WARRANTY OF MERCHANTABILITY OR FITNESS FOR A PARTICULAR PURPOSE, APPLIES TO THE DV CAMCORDER AFTER THE APPLICABLE PERIOD OF EXPRESS WARRANTY STATED ABOVE, AND NO OTHER EXPRESS WARRANTY OR GUARANTY, EXCEPT AS MENTIONED ABOVE, GIVEN BY ANY PERSON, FIRM OR CORPORATION WITH RESPECT TO THE DV CAMCORDER SHALL BIND CUSA. (SOME STATES DO NOT ALLOW LIMITATIONS ON HOW LONG AN IMPLIED WARRANTY LASTS, SO THE ABOVE LIMITATION MAY NOT APPLY TO YOU) CUSA SHALL NOT BE LIABLE FOR LOSS OF REVENUES OR PROFITS, EXPENSE FOR SUBSTITUTE EQUIPMENT OR SERVICE, STORAGE CHARGES, LOSS OF DATA, OR ANY OTHER SPECIAL, INCIDENTAL OR CONSEQUENTIAL DAMAGES CAUSED BY THE USE, MISUSE OR INABILITY TO USE THE DV CAMCORDER, REGARDLESS OF THE LEGAL THEORY ON WHICH THE CLAIM IS BASED, AND EVEN IF CUSA HAS BEEN ADVISED OF THE POSSIBILITY OF SUCH DAMAGES. NOR SHALL RECOVERY OF ANY KIND AGAINST CUSA BE GREATER IN AMOUNT THAN THE PURCHASE PRICE OF THE DV CAMCORDER SOLD BY CUSA AND CAUSING THE ALLEGED DAMAGE. WITHOUT LIMITING THE FOREGOING, YOU ASSUME ALL RISK AND LIABILITY FOR LOSS, DAMAGE OR INJURY TO YOU AND YOUR PROPERTY AND TO OTHERS AND THEIR PROPERTY ARISING OUT OF USE, MISUSE OR INABILITY TO USE THE DV CAMCORDER NOT CAUSED DIRECTLY BY THE NEGLIGENCE OF CUSA. (SOME STATES DO NOT ALLOW THE EXCLUSION OR LIMITATION OF INCIDENTAL OR CONSEQUENTIAL DAMAGES, SO THE ABOVE LIMITATION MAY NOT APPLY TO YOU.) THIS LIMITED WARRANTY SHALL NOT EXTEND TO ANYONE OTHER THAN THE ORIGINAL PURCHASER OF ANY DV CAMCORDER, OR THE PERSON FOR WHOM IT WAS PURCHASED AS A GIFT, AND STATES YOUR EXCLUSIVE REMEDY.

This limited warranty gives you specific legal rights, and you may also have other rights which vary from state to state.

Canon U.S.A., Inc.
One Canon Plaza
Lake Success, New York 11042

**Additional
Information**

CANADA

E

CANON CONSUMER DIGITAL VIDEO EQUIPMENT LIMITED WARRANTY

The limited warranty set forth below is given by Canon Canada Inc. ("Canon Canada") with respect to Canon digital video equipment purchased in Canada. This limited warranty is only effective upon presentation of a bill of sale or other proof of purchase for this Canon digital video equipment to a Canon Service Facility when repairs are required.

Canon consumer video digital equipment is warranted under normal, non-commercial, personal use, against defective materials or workmanship as follows:

Parts: Defective parts will be exchanged for new parts or, at Canon Canada's option, comparable rebuilt parts for a period of one year from the date of original purchase, except Video Heads which will be exchanged for a period of 3 months from the date of purchase.

Labour: For a period of one year from the date of original purchase, labour will be provided free of charge by our Canon Service Facilities in Canada.

This limited warranty covers all defects except where:

- (a) The loss or damage to the product results from:
 - i) accident, natural disaster, mishandling, abuse, neglect, unauthorized product modification or failure to follow instructions contained in the instruction manual;
 - ii) the use of accessories, attachments, products, supplies, parts or devices with this Canon product that do not conform to Canon specifications or that cause abnormally frequent service problems;
 - iii) repairs or services performed by any party other than a Canon Service Facility;
 - iv) defective batteries or any exposure to water, sand or dirt;
 - v) shipping (claim must be presented to the shipper);
 - (b) Any serial number on the video equipment is altered or removed.
 - (c) The digital video equipment is used for commercial, professional or industrial purposes.
- This limited warranty does not cover the cabinet (exterior finish) of the digital video equipment, video cassette tapes, head cleanings, nor does it apply to digital video equipment purchased outside Canada.

TO OBTAIN WARRANTY SERVICE

Ship your Canon digital video equipment in its original carton, box or equivalent, properly packed, fully insured with shipping charges prepaid, together with a copy of your bill of sale or other proof of purchase and a description of the problem to any of the Canon Service Facilities in Canada.

LIMITATIONS

Except as otherwise required by applicable legislation, this warranty is in lieu of all other warranties, conditions, guarantees or representations, express or implied, statutory or otherwise, relative to this Canon product, including implied warranties or conditions of merchantability or fitness for a particular purpose.

Canon Canada assumes no liability for special, consequential or incidental damages or loss that may arise, whether on account of negligence or otherwise, from the use, misuse or inability to use this Canon product (including loss of profit, revenue, video tapes or enjoyment) or from failure to conform to any express or implied warranties, conditions, guarantees or representations. Any recovery under this limited warranty shall not exceed the purchase price of the product. Canon Canada does not assume or authorize any other person to assume for Canon Canada any other liability with respect to this Canon product.

This warranty does not extend to any person other than the original purchaser of this Canon product or the person for whom it was purchased as a gift and states your exclusive remedy.

NOTICE TO CONSUMER

If you plan to take important videos or if the product has not been used for some time, please check all functions with the instruction book before using it.

Canon

CANON INC.

U.S.A. ————— **CANON U.S.A., INC. NEW JERSEY OFFICE**
100 Jamesburg Road, Jamesburg, NJ 08831 USA

CANON U.S.A., INC. CHICAGO OFFICE
100 Park Blvd., Itasca, IL 60143 USA

CANON U.S.A., INC. LOS ANGELES OFFICE
15955 Alton Parkway, Irvine, CA 92618 USA

CANON U.S.A., INC. HONOLULU OFFICE
210 Ward Avenue, Suite 200, Honolulu, HI 96814 USA

- **If you have any questions, call the Canon U.S.A. Information Center toll-free at 1-800-828-4040 (U.S.A. only).**

CANADA ————— **CANON CANADA INC. NATIONAL HEADQUARTERS**
6390 Dixie Road, Mississauga, Ontario L5T 1P7

CANON CANADA INC. CALGARY
2828, 16th Street, N.E. Calgary, Alberta T2E 7K7

CANON CANADA INC. MONTREAL
5990 Côte de Liesse, Quebec H4T 1V7

- **If you have any questions, call the Canon Canada Information Center toll-free at 1-800-828-4040. (Canada only)**

- **Si vous avez des questions, veuillez téléphoner sans frais au Canada 1-800-828-4040. (Canada seulement)**

MEXICO ————— **CANON MEXICANA, S. DE R.L. DE C.V.**
Periférico Sur No. 4124 Col. Ex-Rancho de Anzaldo C.P. 01900
México, D.F., México

CENTRO Y SURAMÉRICA ————— **CANON LATIN AMERICA, INC.**
703 Waterford Way Suite 400 Miami, FL 33126 USA

ASIA ————— **CANON HONGKONG COMPANY LTD.**
19/F., The Metropolis Tower, 10 Metropolis Drive, Hunghom, Kowloon, Hong Kong



Printed on 100% reused paper.
Document réalisé avec du papier recyclé à 100%.
El papel aquí utilizado es 100% reciclado.